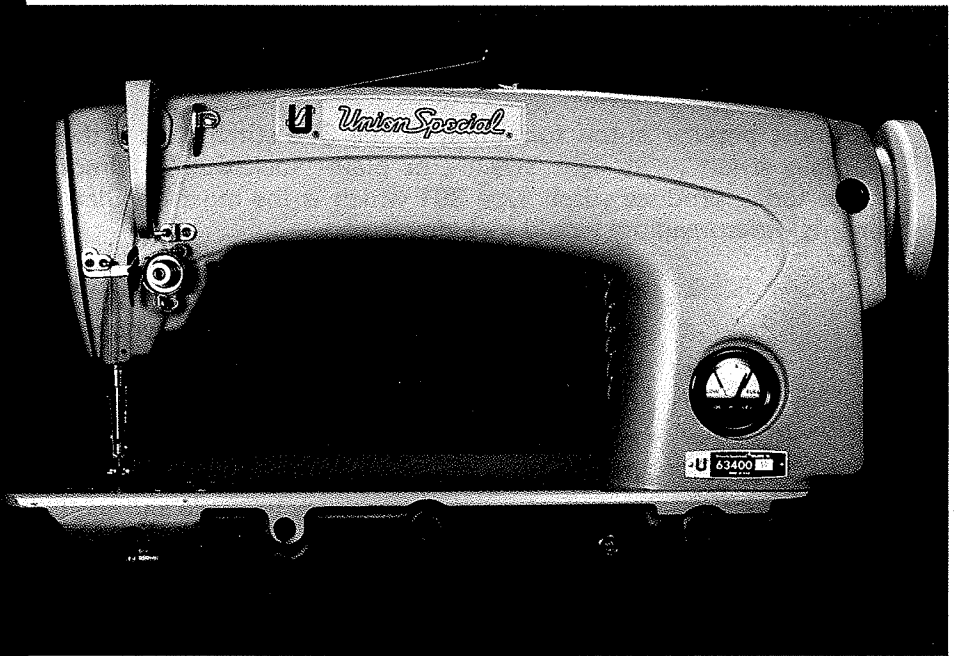
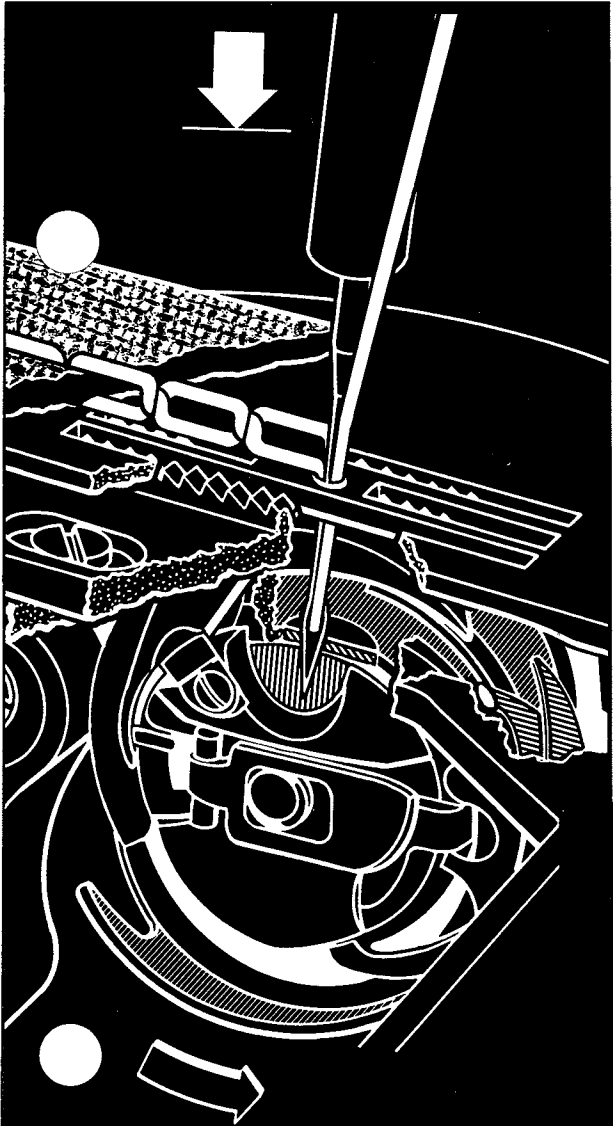
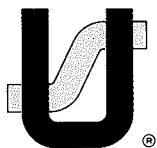


*Union Special*  
**LOCKSTITCH  
FORMATION  
TYPE 301**



The information presented in this booklet has been prepared by Union Special Corporation, Technical Training Center, to acquaint sewing production people with details surrounding stitch type 301, as defined in the United States Government Specification Booklet 751 A.



FINEST QUALITY

*Union Special*<sup>®</sup>

Technical Training Center  
12005 4th Street Huntley, Illinois 60142

## TABLE OF CONTENTS

Subject	Pages
Introduction . . . . .	2
301 Stitch Theory . . . . .	7
Other Methods of Forming the 301 Stitch . . .	17
Adjustments . . . . .	19
Technical Data . . . . .	30
Skipped & Improper Stitches . . . . .	35
Needle Positioners & Thread Trimmers . . . . .	37
Other 300 Class Stitch Types . . . . .	38

## INTRODUCTION

The 300 stitch class includes stitch types that interlock a needle thread with a bobbin thread by the use of a **hook** or shuttle mechanism. Because these threads are interlocked rather than interlooped, the 300 stitch class is better known as the **LOCKSTITCH** class of stitches.

The most popular stitch formation in the 300 stitch class is the 301 stitch which is often referred to as a "plain stitch", "straight stitch", or plain "lockstitch". Almost half of all industrial sewing machines in use today produce stitch type 301 which is the most popular stitch used in the industry. Some reasons for this widespread use would include:

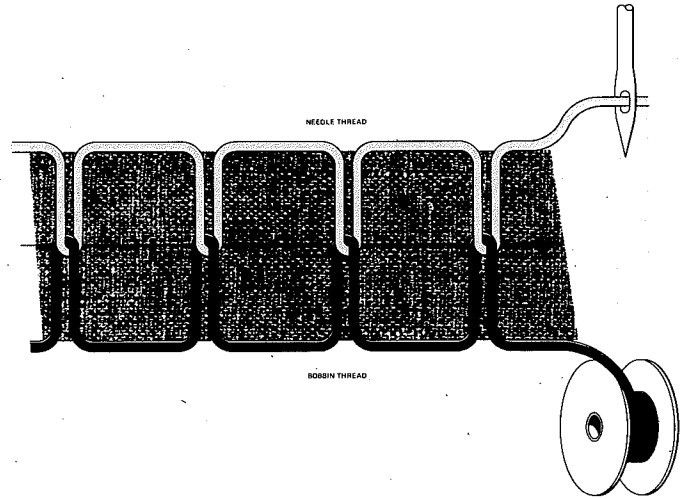
- the stitch is reversible and looks the same on both sides;
- it is the tightest stitch formation which minimizes seam grinning;
- it consumes the least amount of thread in its formation;
- it has a better "hand", or feels smoother to the touch;
- lockstitch machines usually have a lower initial investment than machines producing other stitches;
- lockstitch machines are very versatile and can be used on a variety of operations.

The basic concept of carrying a needle loop around a bobbin may seem very simple, but when you consider:

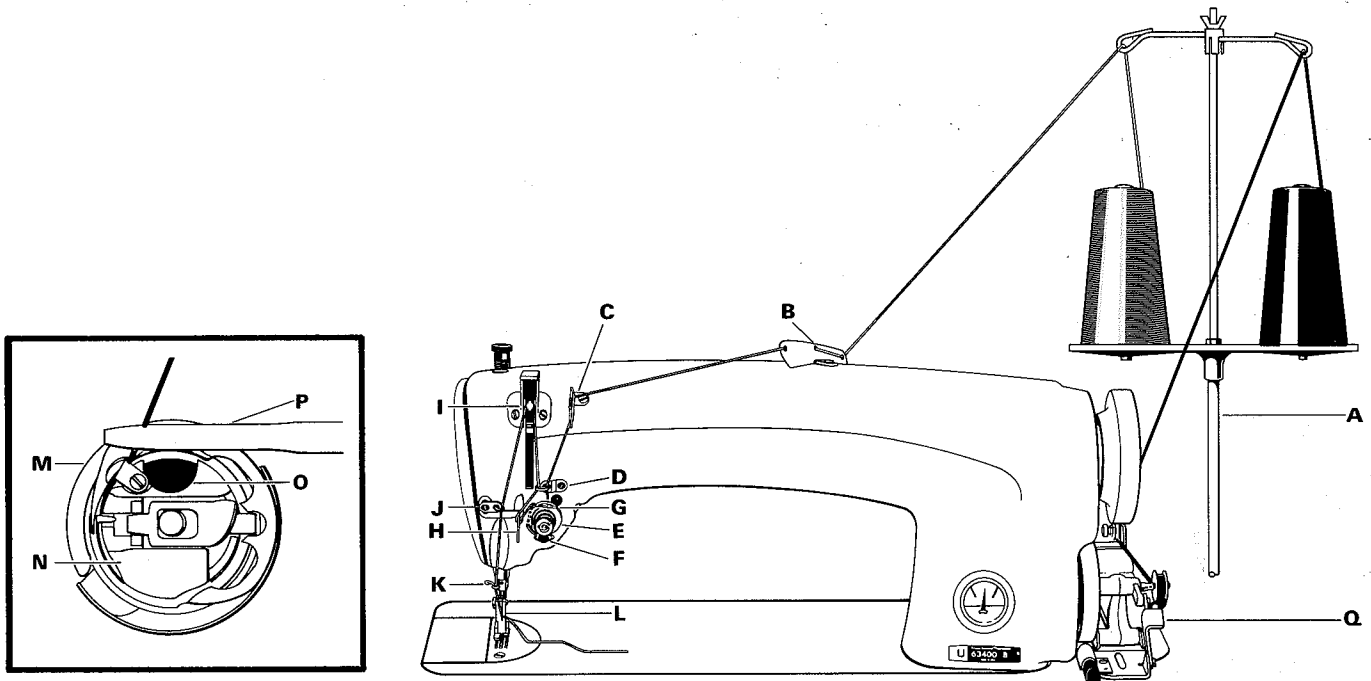
- that the rotary hook used to interlock the threads rotates at speeds up to 12,000 revolutions per minute;
- that approximately 3½ inches or 8.9 cm of needle thread is carried below the material and around the bobbin during the formation of each stitch, even though only one stitch length of thread is consumed;
- that the stitch must appear the same on both sides of the seam which sometimes is only .020 of an inch thick . . .

You may begin to question how simple the formation of the 301 stitch really is:

**Fig. 2** In the 301 stitch formation, needle thread which is supplied from a cone of thread is passed through the material and carried around a bobbin which has been wound with thread. The needle thread is then pulled up into the middle of the material carrying the bobbin thread with it. The ratio of needle thread to bobbin thread consumed in the 301 stitch formation should be 1 to 1 in a well balanced stitch formation.



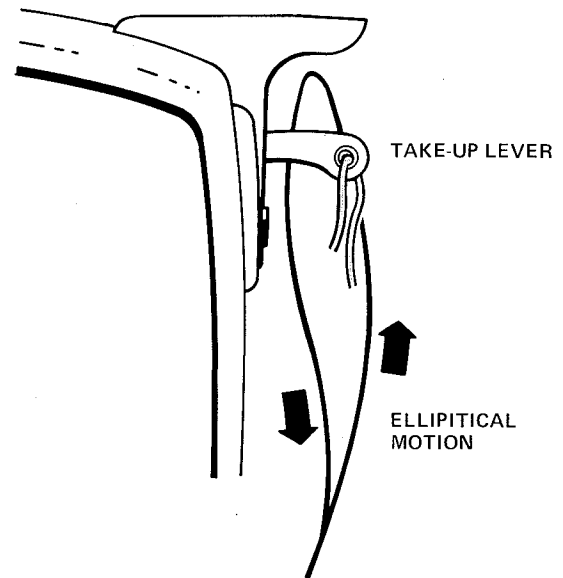
**Fig. 3** This threading diagram emphasized the principle thread handling components and their relationship to one another.



- A. Thread Stand
- B. Top Frame Thread Eyelet
- C. Front Frame Thread Eyelet
- D. Thread Guide
- E. Needle Thread Tension Assembly
- F. Tension Post Eyelet (Snubber)
- G. Take-up Spring (Check Spring)
- H. Needle Thread Pull-up Bracket (Gooseneck)

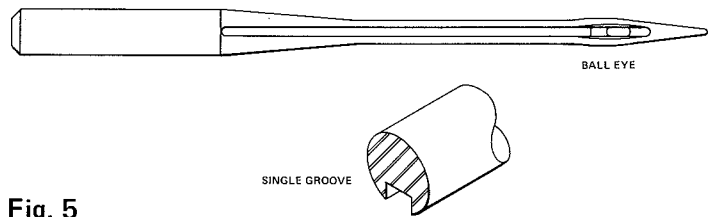
- I. Take-up Lever
- J. Thread Eyelet
- K. Needle Bar Bushing Thread Guide
- L. Needle
- M. Rotary Hook Assembly
- N. Bobbin Case
- O. Bobbin
- P. Positioning Finger
- Q. Bobbin Winder

**Fig. 4** The principle element used to control the needle thread is the **Take-up** lever which travels up and down in an **elliptical** motion rather than a straight up and down motion. This motion is necessary to allow the take-up to deliver thread slowly to the hook on its down stroke, but take-up thread rapidly on its upstroke so the thread can be pulled out of the hook, the stitch can be set, and the needle thread drawn from the cone. Actually, the take-up lever travels almost twice as fast on its upstroke as it does on the down stroke.



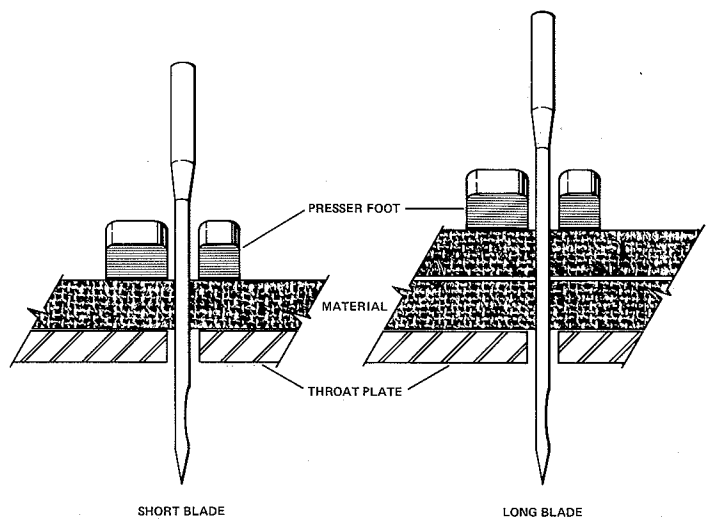
**Fig. 4**

**Fig. 5** Most needles used in lockstitch machines have a single groove because the stitch is set when the needle is out of the material. They also have a ball eye which opens up a larger needle hole in the material allowing the needle thread controls to set the stitch in the middle of the material with the least amount of resistance.



**Fig. 5**

**Fig. 6** Most Union Special lockstitch machines can use two different lengths of needles depending on what is to be sewn. Usually a longer blade needle is used to sew thicker materials because there is a greater distance from the shoulder of the needle to the top of the presser foot bottom when the needle is all the way down. However, the shorter the needle blade, the less the needle vibration which gives more uniform needle penetration.



**Fig. 6**

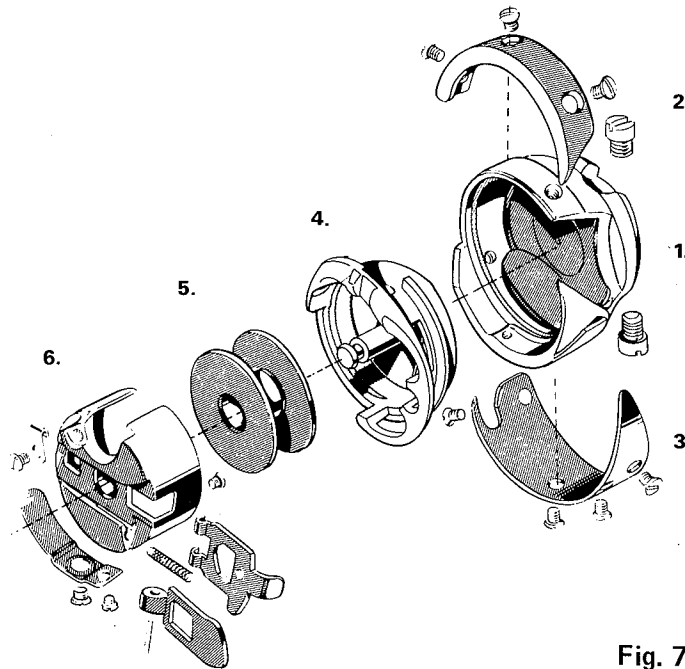


Fig. 7

**Fig. 7** The stitch forming device used in most of today's high speed lockstitch machines is a rotary hook assembly, which makes two revolutions for every one revolution of the handwheel. One revolution is used to handle the thread and the other revolution while the stitch is being set and the feed dog is finishing its feeding cycle.

The major components of the hook assembly include:

1. Hook Base
2. Retainer
3. Thread Deflector
4. Basket (Bobbin Case Holder)
5. Bobbin
6. Bobbin Case Assembly

**Fig. 8** Key areas of the Hook Base are the hook point, the thread stop, and the raceway. The hook base rotates at speeds of up to 12,000 revolutions per minute or 200 revolutions per second.

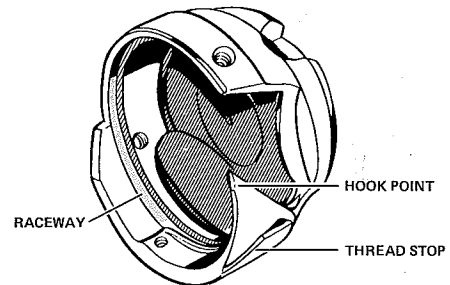


Fig. 8

**Fig. 9** Key areas of the basket include the rail with the detainer point, the needle guarding area, and the positioning finger recess. As the hook rotates, the basket remains in a constant position because of the positioning finger. Notches have been cut in the rail to cut the thread if it gets between the rail and the raceway.

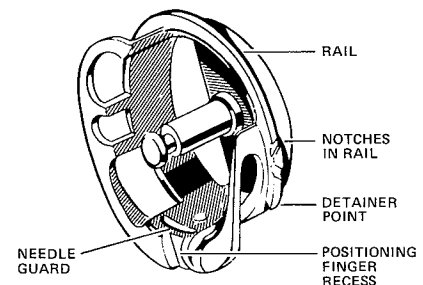
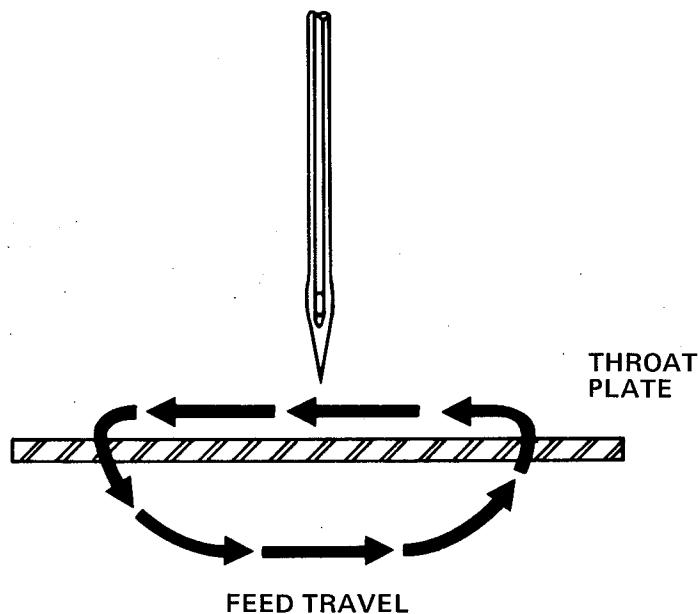
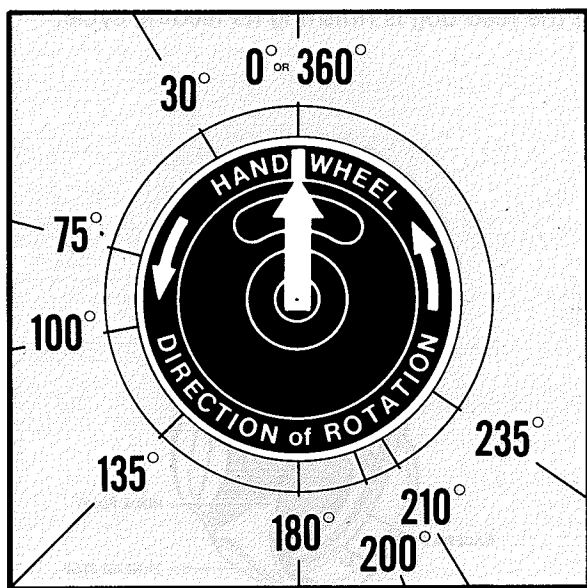


Fig. 9

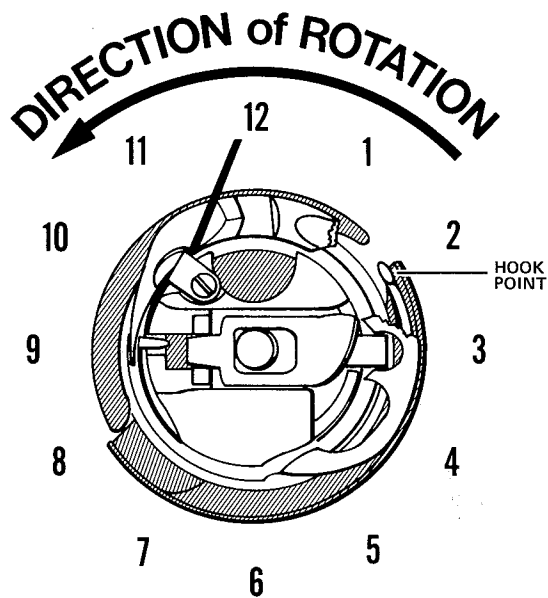
**Fig. 10** In this presentation a plain feed drop feed system will be used to feed the material away from the operator. With this system the needle is out of the material prior to the feed dog rising above the throat plate to move the material. On a 63400 machine, the material will begin to be fed as the needle approaches the top of its stroke.



**Fig. 10**



**Fig. 11**



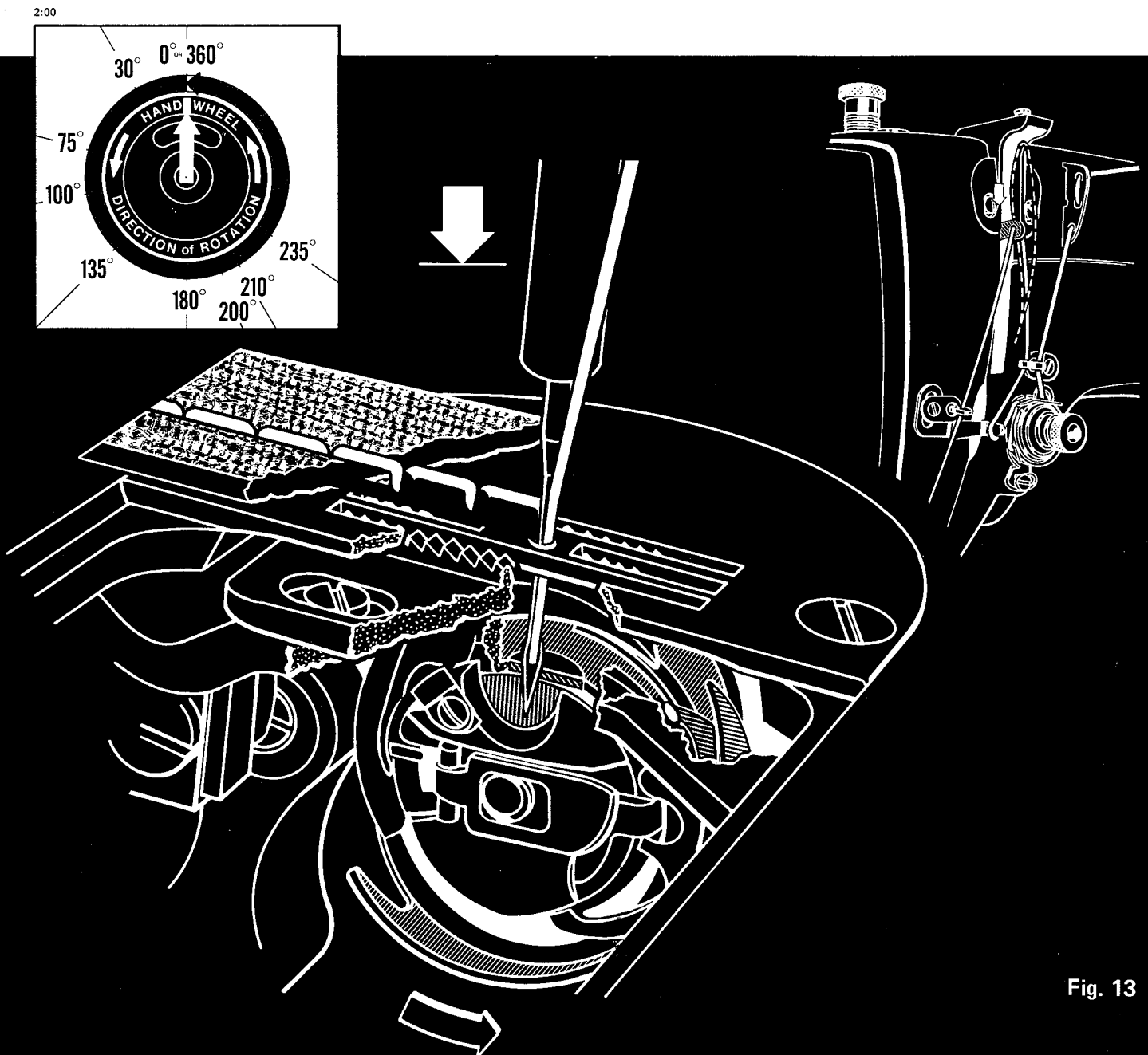
**Fig. 12**

**Fig. 11 & 12** To illustrate how the 301 stitch is formed on a 63400 machine, the handwheel will be referred to as a compass and the front view of the hook as the face of a clock. At the 0 degree position, the needle will be at the bottom of its travel and the hook point will be approximately at the 2 o'clock position. The handwheel rotates counter clockwise when facing it from the handwheel end of the machine, while the rotary hook rotates counter clockwise when facing it from the hook end of the machine.

In the following ten views we are going to show the relationship between the needle, feed dog, hook, take-up, and check spring when forming the 301 stitch.

**Fig. 13 The Handwheel is at the 0 Degree Position**

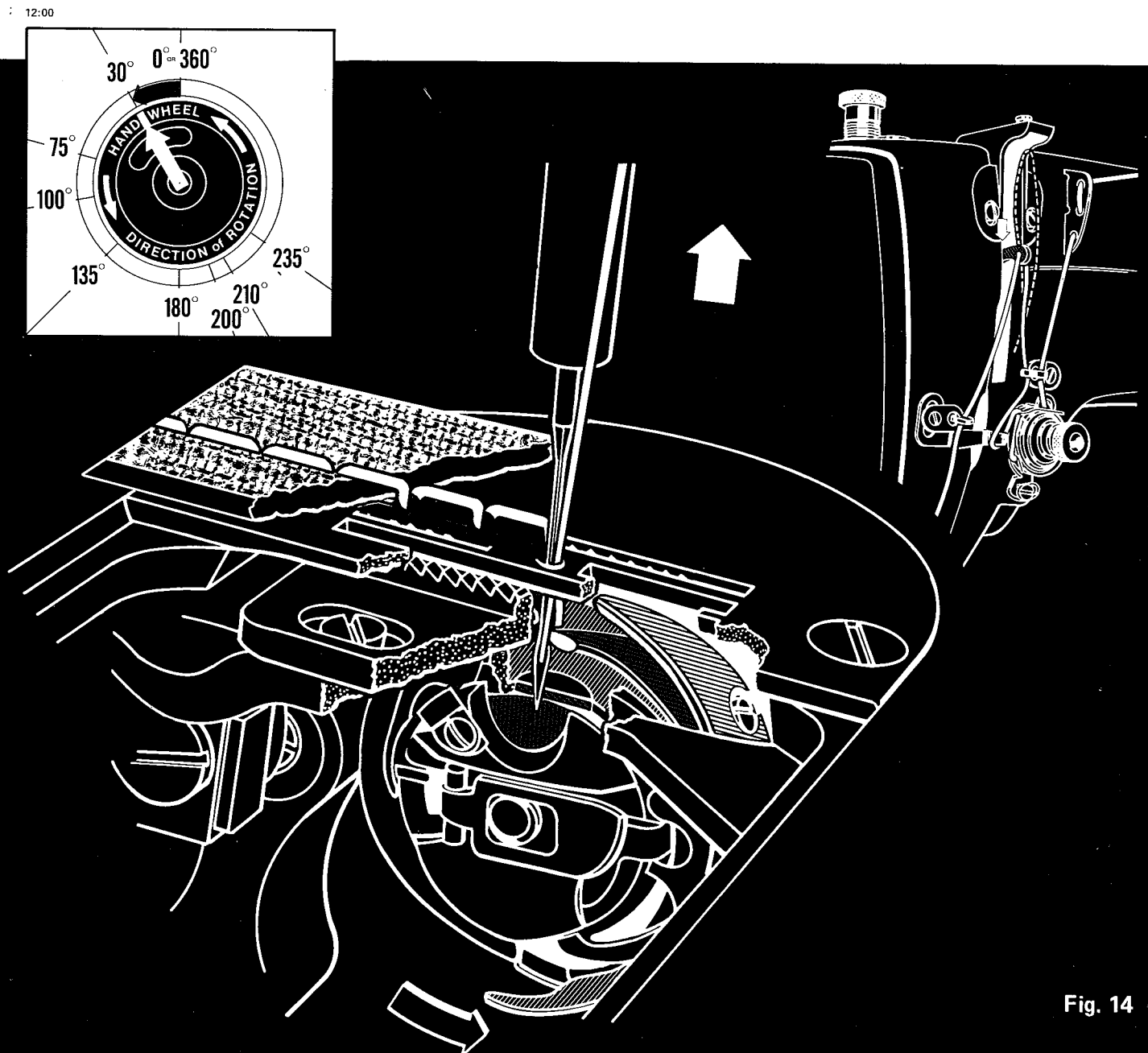
1. The needle is at the bottom of its travel and has entered the needle guard slot in the basket. The main purpose of this guarding surface is to stabilize the needle and prevent it from getting into the path of the hook point.
2. The Hook Point is at the 2 o'clock position moving up toward the needle.
3. The Take-up is descending giving slack in the needle thread. This slack will assist in the formation of the needle thread loop.
4. The check spring is inactive as the needle thread is slack. This spring will only move from its stop when the pulling force on the thread overcomes the tension on the check spring.
5. The feed dog is below the throat plate and moving toward the operator.



**Fig. 13**

**Fig. 14 The Handwheel is at the 30 Degree Position**

1. The needle is rising and a needle thread loop is being formed on the scarf side of the needle. The pinching of the thread between the needle blade and the material help to form this loop, provided the material does not move up with the needle. If the material moves with the needle, we call this condition "flagging."
2. The Hook Point is at the 12 o'clock position and is entering the needle thread loop.
3. The Take-up is descending the giving needle thread to help form a good needle loop.
4. The check spring is inactive.
5. The feed dog is below the throat plate and returning toward the operator.



**Fig. 14**



Fig. 15 The Handwheel is at the 75 Degree Position

1. The needle is rising and coming out of the throat plate needle hole.
2. The hook point is at the 9 o'clock position and the top side of the needle thread loop has slipped back against the thread-stop on the hook base. The thread-stop will carry the needle thread supplied by the take-up to the bottom of the hook as the hook base continues to rotate. As the deflector contacts the needle thread loop, the loop is twisted so that the side of the loop that passes over the face of the hook runs to the previously formed stitch.

The underside of the needle thread loop passes under the hook point and across the raceway. This places the needle thread directly in front of the detainer point of the rail. As the needle thread is carried toward the bottom of the hook, the detainer acts as a pivot point so the needle thread loop can completely encircle the basket.

3. The Take-up is descending the giving needle thread.
4. The check spring is still inactive.
5. The feed dog is returning toward the operator beneath the throat plate.

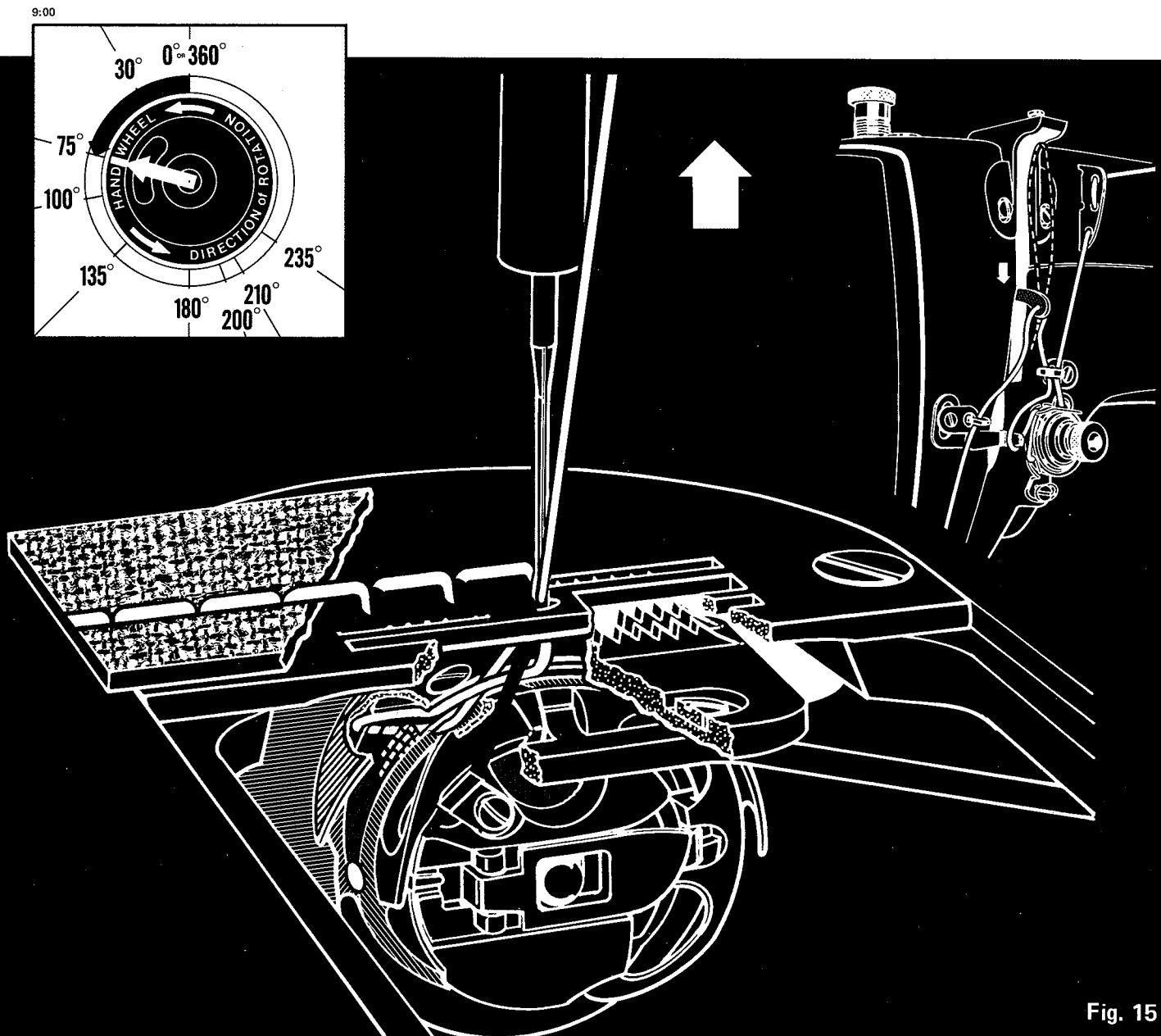


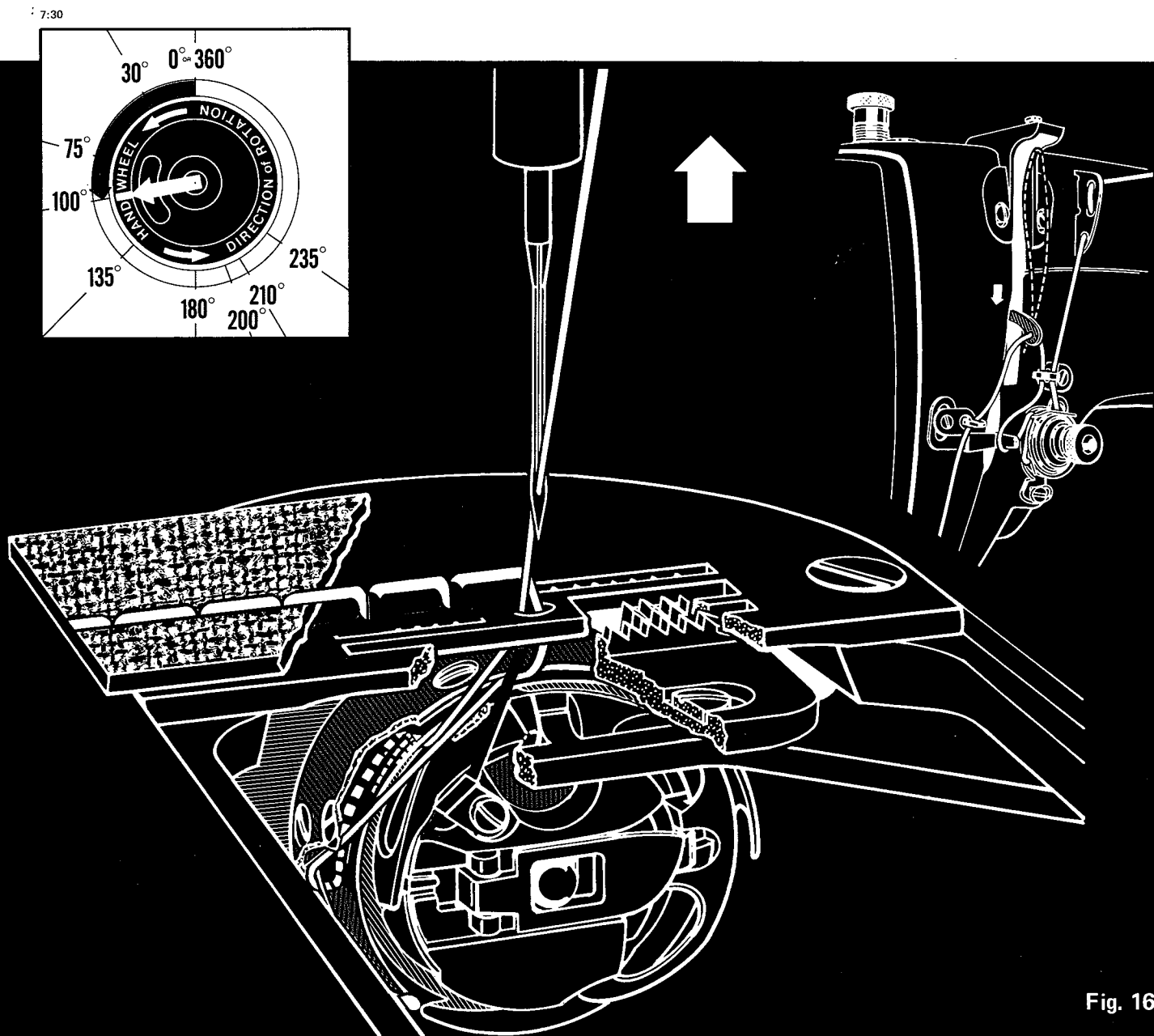
Fig. 15

**Fig. 16 The Handwheel is at the 100 Degree Position**

1. The needle is rising and is out of the material.
2. The hook point is at the 7:30 position. The thread deflector attached to the hook base is lifting the front side of the needle thread over the face of the hook and will place it in a position where it can easily slip into the positioning finger recess of the basket.

The bottom side of the needle loop has contacted the detainer point on the rail and is laying alongside the back of the rail. As the hook base continues to rotate, the needle loop will start to be drawn around the basket.

3. The take-up is still descending and giving needle thread.
4. The check spring is still inactive.
5. The feed dog has returned to the front and is beginning to rise.



**Fig. 16**

Fig. 17 The Handwheel is at the 135 Degree Position

1. The needle is still rising above the material.
2. The hook point is at the 5 o'clock position. The needle thread loop is being drawn down to the 6 o'clock position on both the front and back sides of the basket. At this time the needle thread completely encircles the basket. The front side of the needle thread has now slipped off the thread deflector and into the positioning finger recess of the basket. On many Union Special machines, the hook assembly has been designed to give the basket a rocking motion which allows the needle thread to slip past the positioning finger with the least amount of resistance.
3. The take-up is at the bottom of its travel and has given all the needle thread it had to give.
4. To insure proper stitch setting later in the cycle, a small amount of needle thread must be borrowed at this time from the check spring to allow the needle thread loop to move around the 6 o'clock position of the hook. For this reason, the check spring "winks" or moves from its stop momentarily loaning needle thread to the system.
5. The feed dog is rising and getting ready to start feeding the material.

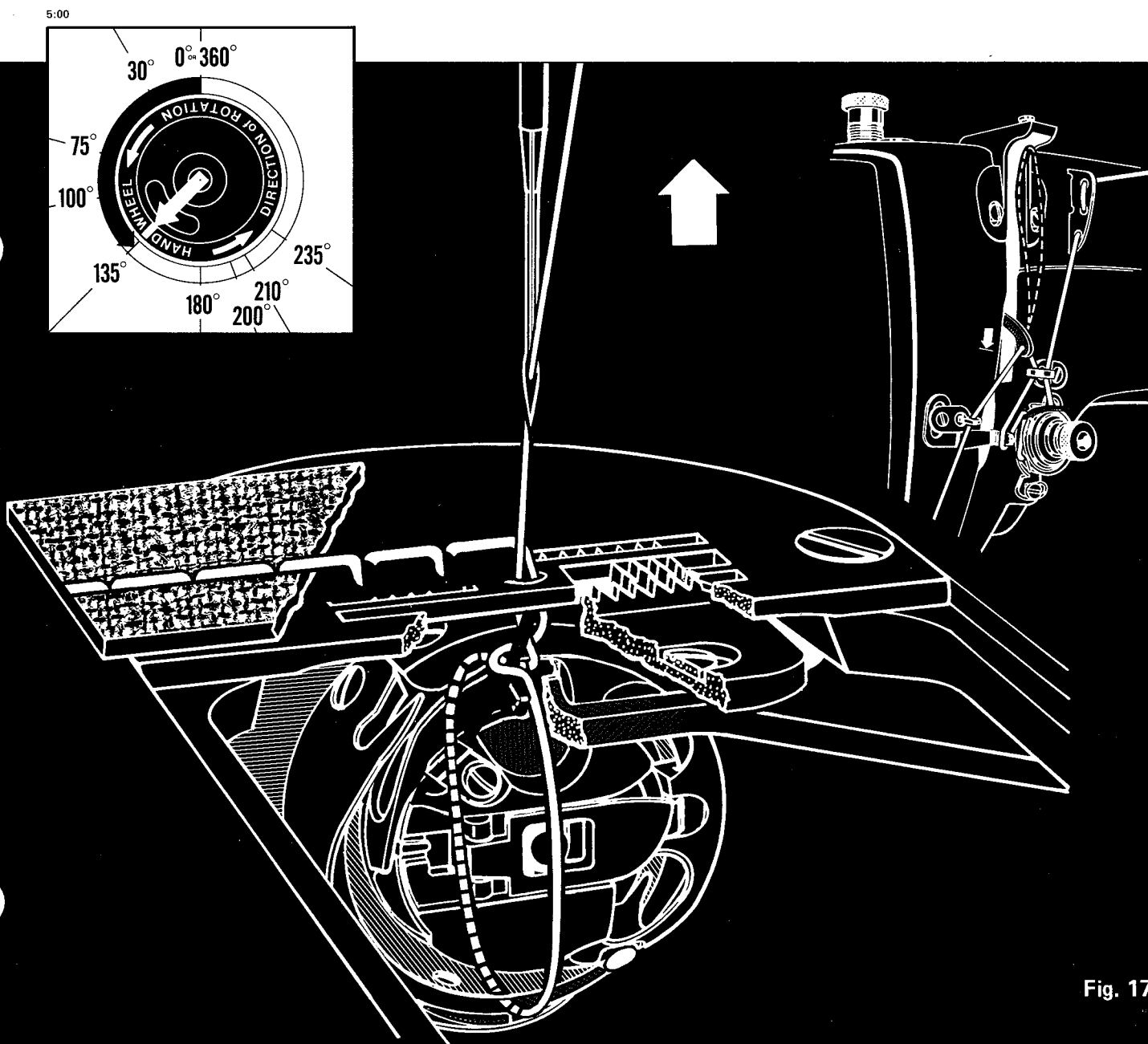
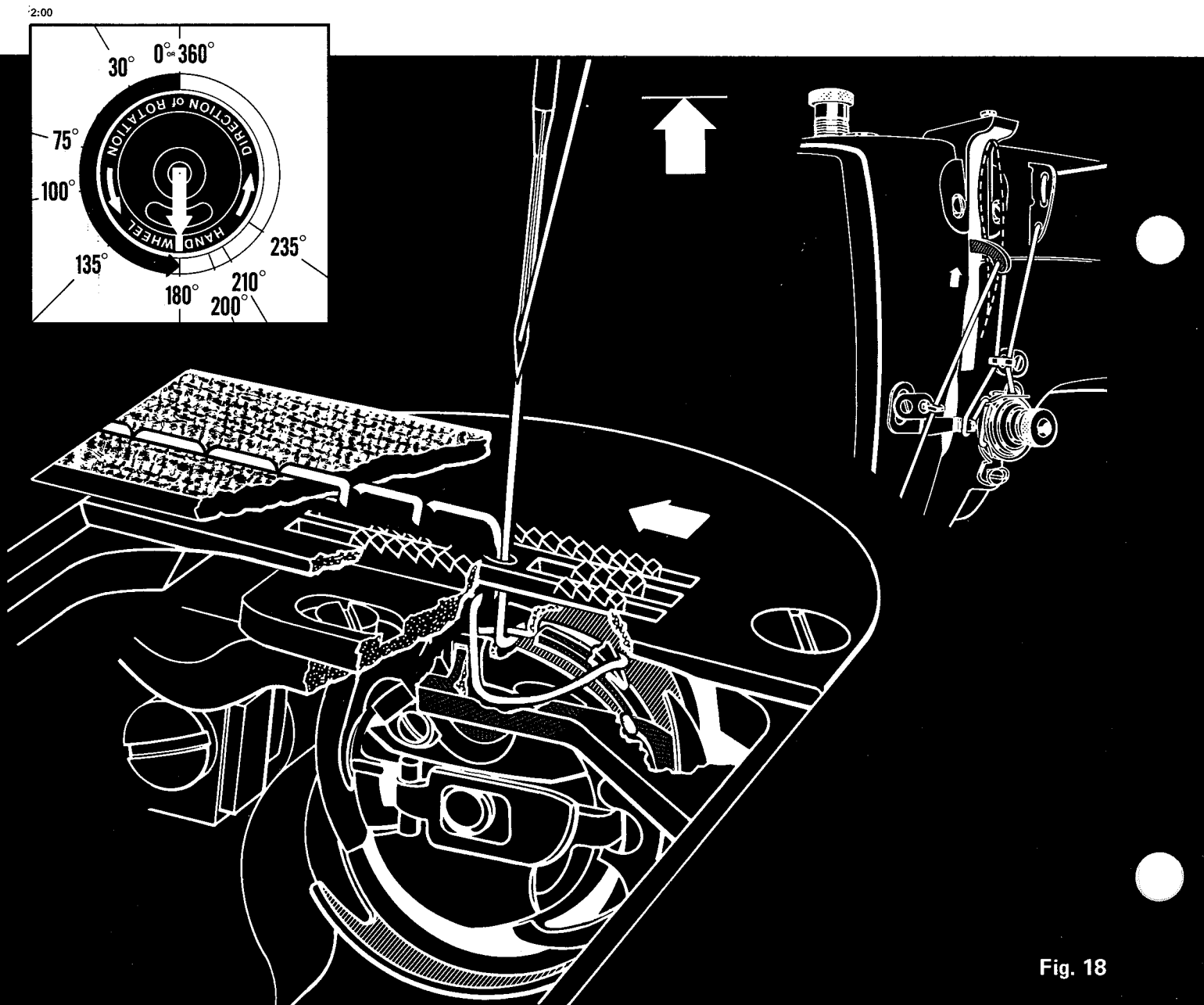


Fig. 17

**Fig. 18 The Handwheel is at the 180 Degree Position**

1. The needle is at the top of its stroke.
2. The hook has made one complete revolution and is once again at the 2 o'clock position. The needle thread loop has been pulled away from the thread stop and off the hook point and is about to be pulled onto the retainer. The front side of the loop is about to slip out of the positioning finger recess of the basket.
3. The take-up is rising rapidly pulling the needle thread loop away from the hook point and onto the retainer. Remember that the take-up travels almost twice as fast on its upstroke as it did on its downstroke.
4. The check spring is inactive and back against its stop.
5. The feed dog is now above the throat plate and beginning to move the material away from the operator.

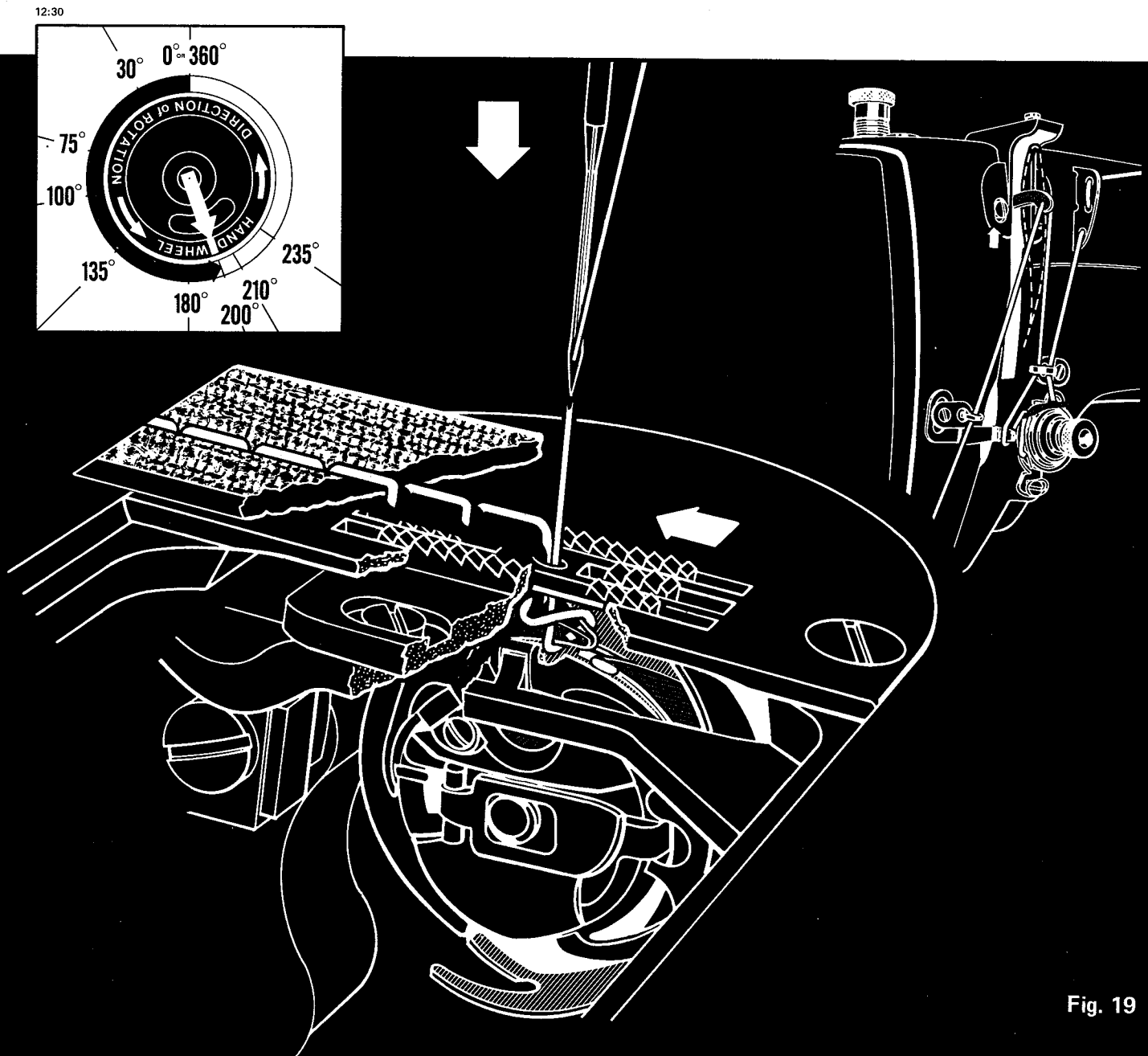
NOTE: A common mistake of inexperienced operators is to position the needle at the top of its travel and try to remove the work from under the presser foot. As you can see, with the loop around the thread retainer, this might prove difficult. However, with the take-up at the top of its travel, the needle thread loop would already have been released making removal of the work considerably easier.



**Fig. 18**

**Fig. 19 The Handwheel is at the 200 Degree Position**

1. The needle is descending from the top of its stroke.
2. The hook point is at the 12:30 position. The needle thread loop has slid out of the positioning finger recess, out from behind the rail on the basket, and is now held by the tip of the thread retainer.
3. The Take-up is rising rapidly and has taken up most of the needle thread which was below the throat plate.
4. When the needle thread contacted the retainer point, the check spring acted as a shock absorber to cushion the force on the thread created by the rapid upward motion of the take-up. As the hook rotates slightly and the needle thread loop slips off the retainer point, the check spring will momentarily return toward its inactive position until the needle thread loop contacts the underside of the material.
5. The feed dog is still moving the material away from the operator.



**Fig. 19**

Fig. 20 The Handwheel is at the 210 Degree Position

1. The needle is descending toward the material.
2. The hook point is at the 12 o'clock position and the needle thread loop has been released from the retainer point.
3. The take-up is still rising and beginning to set the stitch. The needle thread being pulled up toward the underside of the material is carrying the bobbin thread up with it.
4. As the needle thread loop contacts the underside of the material, the check spring will leave its stop for the third time. The check spring will remain depressed until the take-up reaches the top of its stroke and begins to descend giving needle thread. The proper amount of tension on the check spring, needle thread, and bobbin thread work with the take-up and feed motion to set the stitch in the middle of the material.
5. The feed dog is moving the material away from the operator and assisting the take-up in pulling the needle loop with the bobbin thread up into the material.

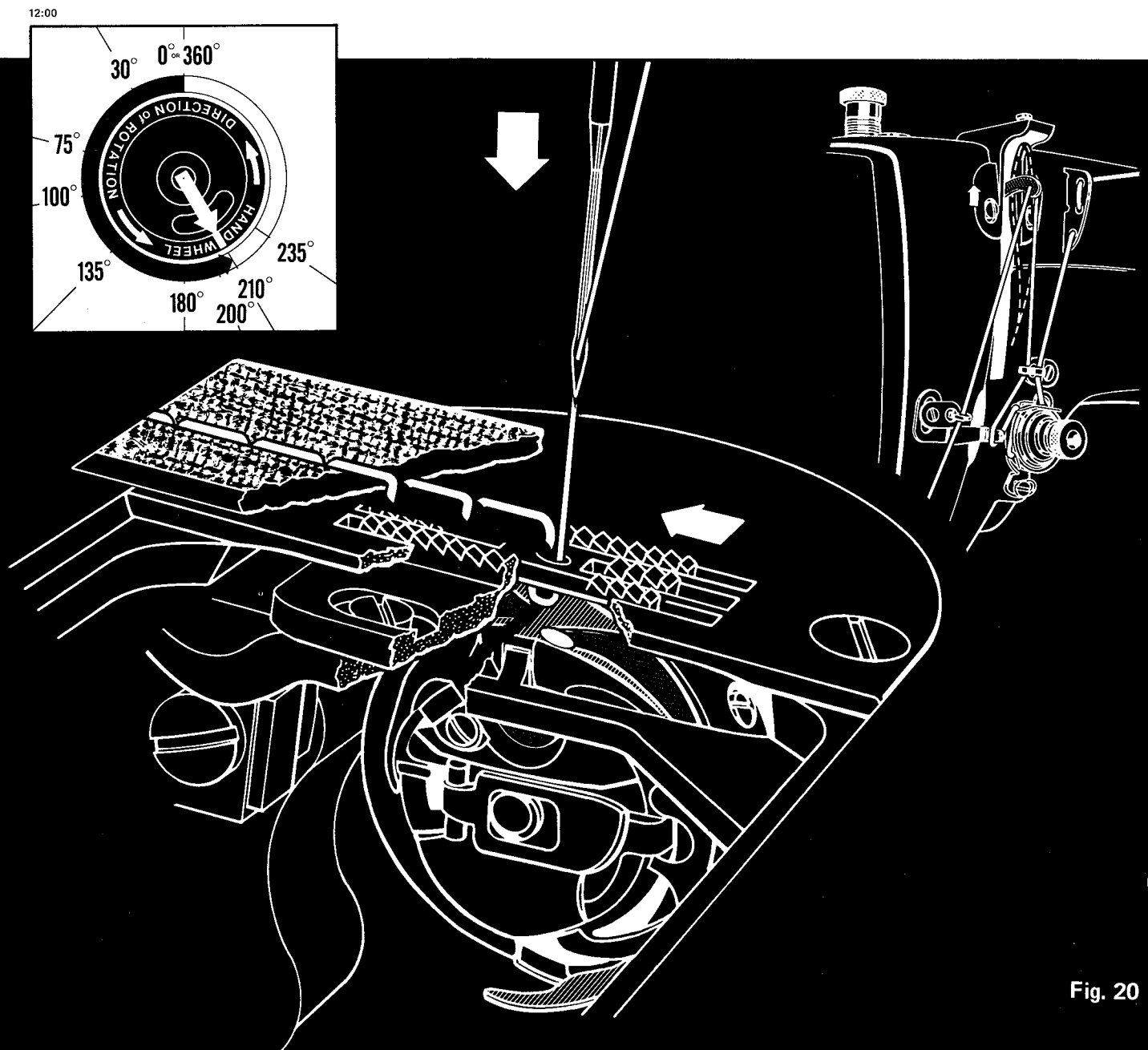
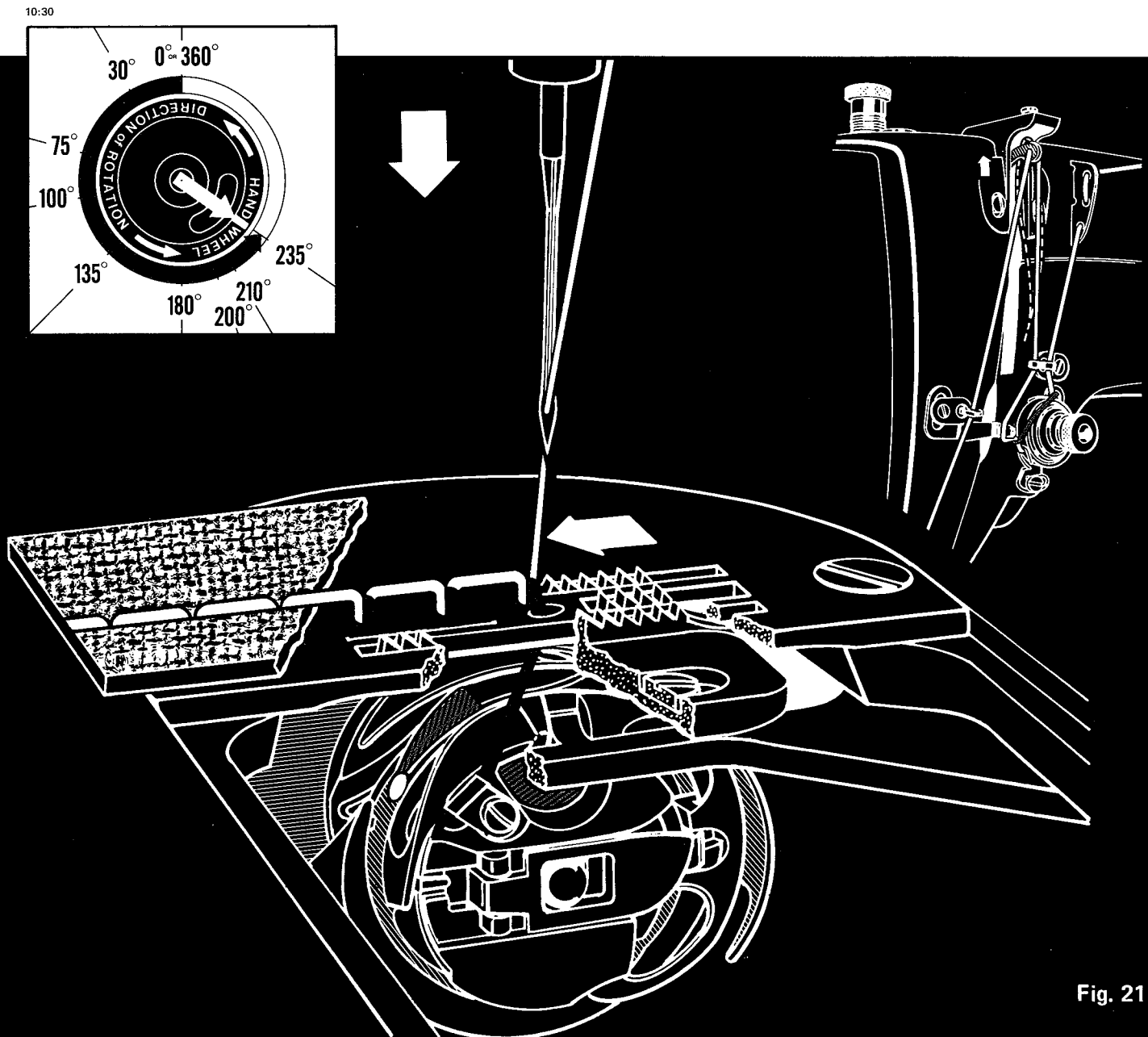


Fig. 20

**Fig. 21 The Handwheel is at the 235 Degree Position**

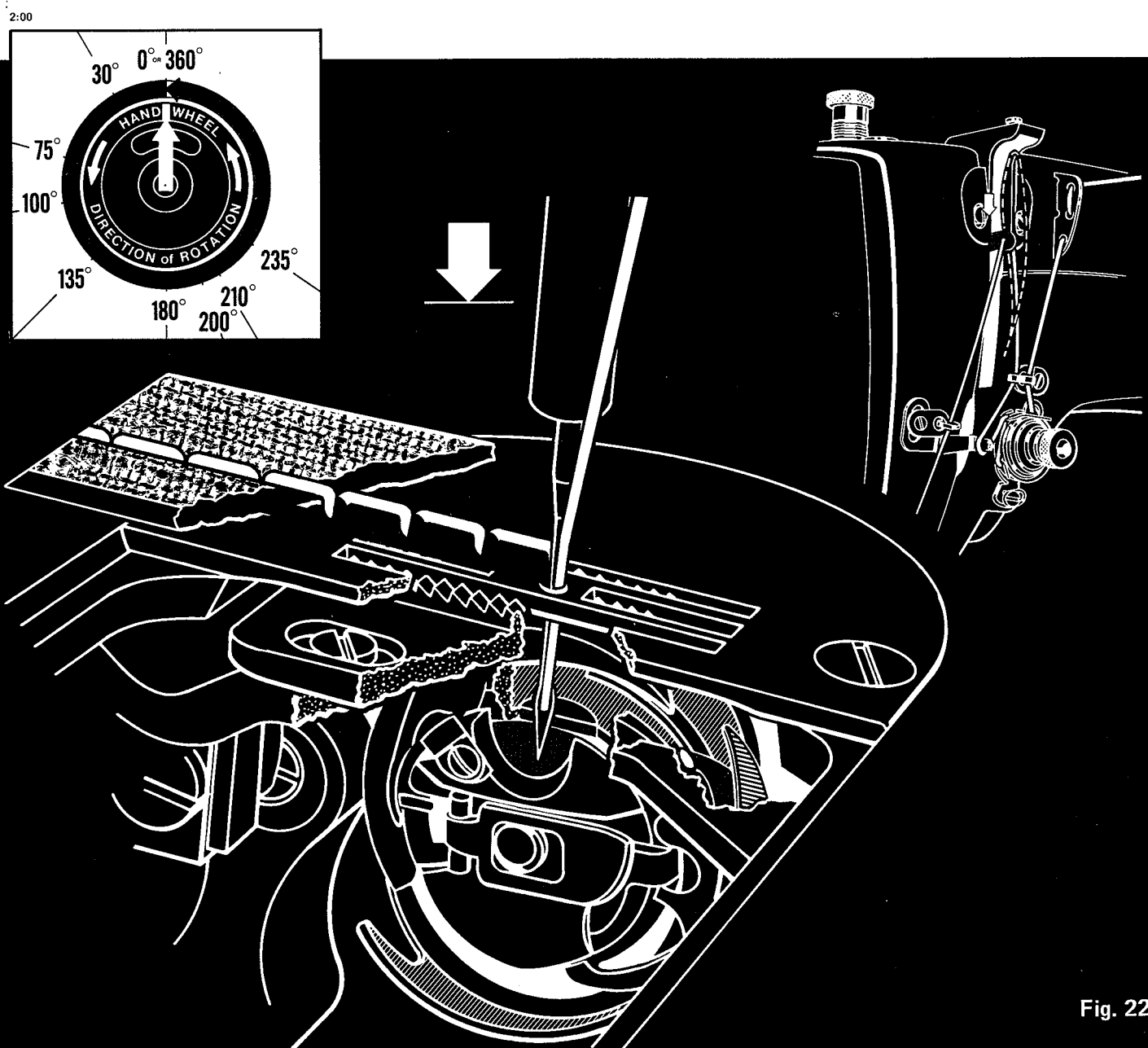
1. The needle is descending toward the material.
2. The hook point is at the 10:30 position, but during this revolution, it will not carry any thread.
3. The take-up is still rising and nearing the top of its travel. As soon as the stitch is set in the middle of the material, needle thread will be drawn from the cone for the next stitch formation, replacing the thread used in the stitch we just formed.
4. The check spring is depressed because the needle thread is still tight due to the upward motion of the take-up.
5. The feed dog is still feeding the material which is helping to draw bobbin thread to be used in the next stitch formation.



**Fig. 21**

**Fig. 22 The Handwheel is at the 360 Degree Position completing One Stitch Formation Cycle**

1. The needle has penetrated the material and again is at the bottom of its stroke.
2. The hook point is at the 2:00 o'clock position and getting ready to begin its thread handling cycle again.
3. The take-up is descending giving needle thread.
4. The check spring is inactive since the take-up began to descend putting slack in the needle thread.
5. The feed dog completed its feeding cycle just before the needle penetrated the material. The feed dog is now below the throat plate and moving back toward the operator.



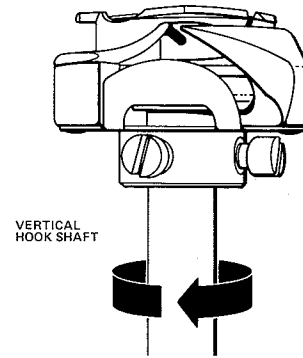
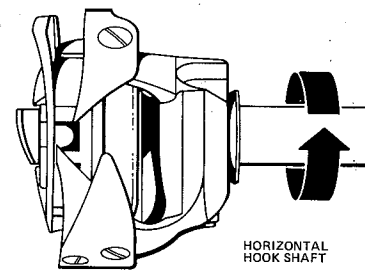
**Fig. 22**



## OTHER METHODS OF FORMING THE 301 STITCH

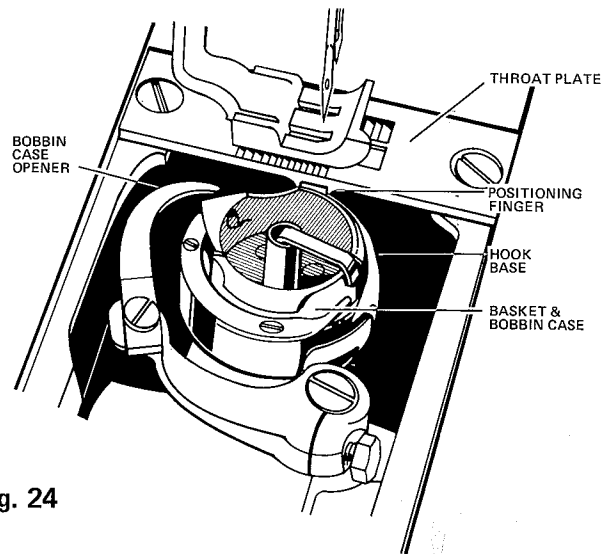
### VERTICAL HOOK SHAFT

**Fig. 23** It should be noted that the previous 301 stitch formation was presented using a rotary hook assembly driven by a horizontal hook shaft. There are, however, machines which use a rotary hook assembly driven by a vertical hook shaft to form the same stitch. Most two needle lockstitch machines use two rotary hooks driven by vertical hook shafts to form two independent rows of 301 stitches simultaneously. Needle spacing variations are possible with this type of mechanism as compared to the horizontal hook shaft mechanism. Needle spacings from 8 ga. to 96 ga. are available on vertical hook shaft machines.



**Fig. 23**

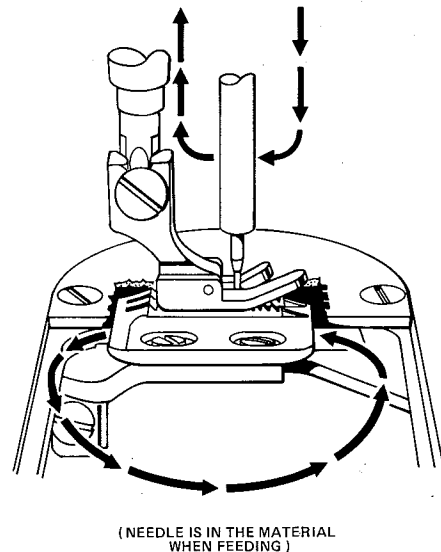
**Fig. 24** The rotary hook assembly used with a vertical hook shaft requires different mechanism than a horizontal hook shaft hook to form the 301 stitch. Usually a vertical hook assembly does not have a removable bobbin case, but combines the bobbin case with the basket. The hook assembly also uses a positioning finger which is part of the basket which sits in the recess of the throat plate. A mechanical bobbin case opener is used to shift the basket, allowing the needle loop to slip past the positioning finger with the least amount of resistance. But even though there are these variations, a horizontal hook machine and a vertical hook machine form the 301 stitch in the same way.



**Fig. 24**

### NEEDLE FEED LOCKSTITCH MACHINES

**Fig. 25** In the previous stitch formation, we used a plain feed, drop feed system to move the material away from the operator. When the material was being fed the needle was up and out of the material. A needle feed system feeds the material with the needle down and moving with the material. The primary purpose of this type of feed system is to reduce mismatching of fabric plies and to increase the feed power.



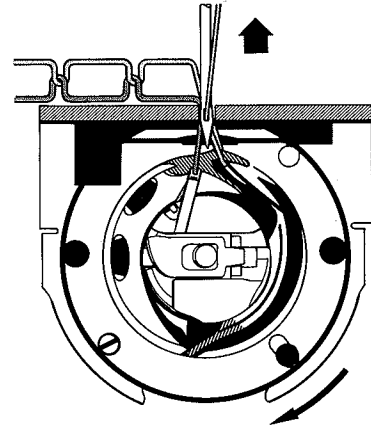
**Fig. 25**

## OTHER METHODS OF FORMING THE 301 STITCH

### OSCILLATING HOOK OR SHUTTLE

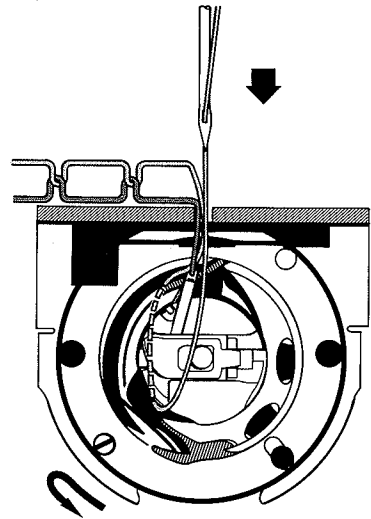
**Fig. 26** One of the oldest ways of forming a 301 stitch is with an oscillating hook mechanism. In this system the shuttle, which is also the bobbin case holder, floats freely in the raceway and is driven by a shuttle drive mechanism. As the needle rises, the point of the shuttle enters the needle loop and continues on its downward motion. During this downward motion, the needle loop slips around the shuttle and around the bobbin. As the shuttle point reaches the bottom of its stroke and reverses its direction, the needle loop is released.

Fig. 26



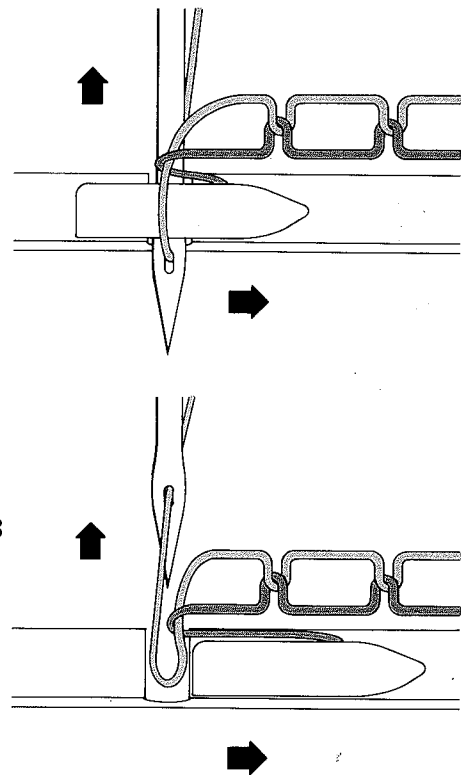
**Fig. 27** During the reverse direction or upward motion of the shuttle, the take-up along with the feed motion pull the needle loop up through the needle hole in the throat plate. The stitch is set as the machine completes its feeding cycle. The shuttle and shuttle drive move back up toward their original position so the thread handling cycle can begin again.

Fig. 27



**Fig. 28** There is also a "bullet" shaped shuttle that passes completely through the needle loop. This type of mechanism is also very old and is still used today in making leather goods such as saddles. The basic stitch formation is similar to that formed with an oscillating shuttle mechanism except that the bullet shaped shuttle is usually driven forward and backward. The forward motion passes the bobbin thread through the needle loop while the backward motion gives the machine time to feed the material and set the stitch.

Fig. 28



## ADJUSTMENTS

The following adjustments are for a 63400 machine producing stitch type 301, however, many of these adjustments are common to other lockstitch machines. We suggest that you consult your catalog for specific dimensions and adjustments for your particular machine style.

### FEED TIMING

Feed Timing is the relationship between the motion of the needle and the motion of the feed dog, and how they work in conjunction to one another to help form and set the stitch. On 63400 Class machines having an upper and lower shaft which are connected by a belt, feed timing is obtained by the relationship of these two shafts.

**Fig. 29** The feed timing can be checked on a 63400 machine by rotating the handwheel until the needle is at the top of its travel. At this time, the timing line marked "4" on the Feed Drive Eccentric, should line up with the timing line on the casting.

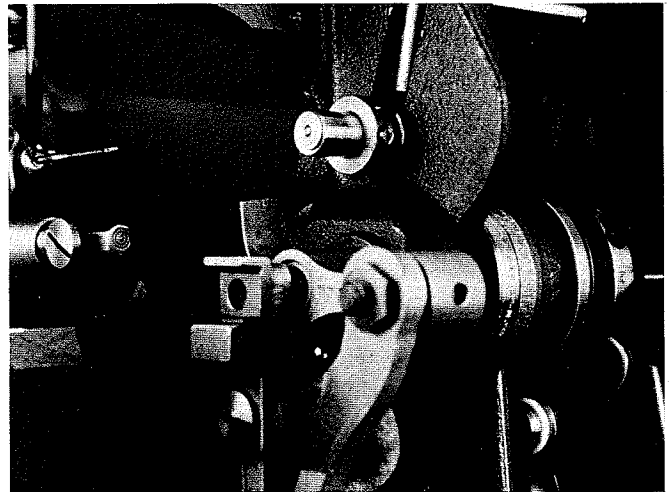


Fig. 29

**Fig. 30** To change feed timing, loosen the screws securing the sprocket to the lower shaft. Then with the needle at the top of its stroke, rotate the lower shaft until the timing lines are aligned. Retighten the screws securing the sprocket to the lower shaft. Make sure no end shake is left in the lower shaft after this adjustment has been made. Hook timing must always be rechecked after making a feed timing adjustment.

**Note:** It is not necessary to remove the bottom cover for this adjustment. The allen wrench can be inserted through the plug screw hole. The needle should be removed when making this adjustment.

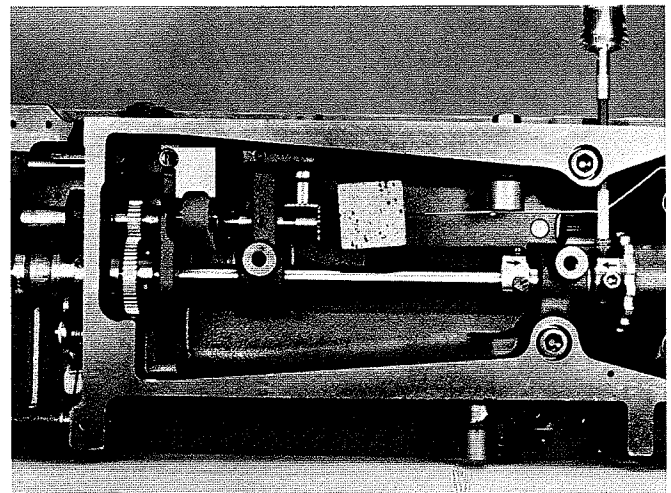


Fig. 30

**Fig. 31** Sometimes it is advantageous to slightly retard the feed timing allowing a longer period for the stitch to be set. When more feed action is used to set the stitch, usually less thread tension is required resulting in flatter seams. This is accomplished by setting the line marked "4" on the feed drive eccentric slightly in front of the timing line on the casting.

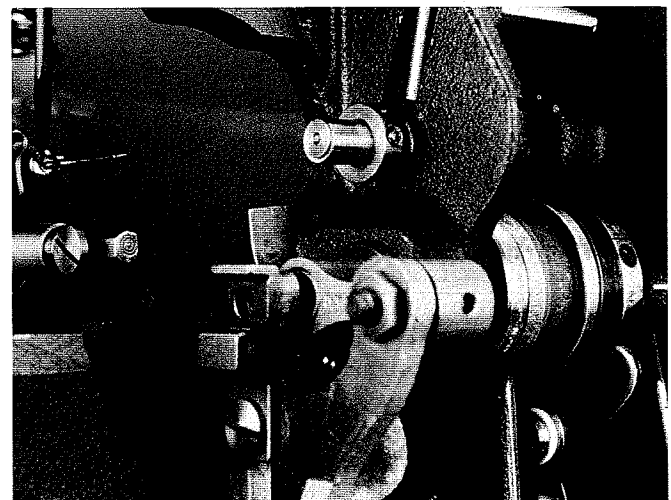
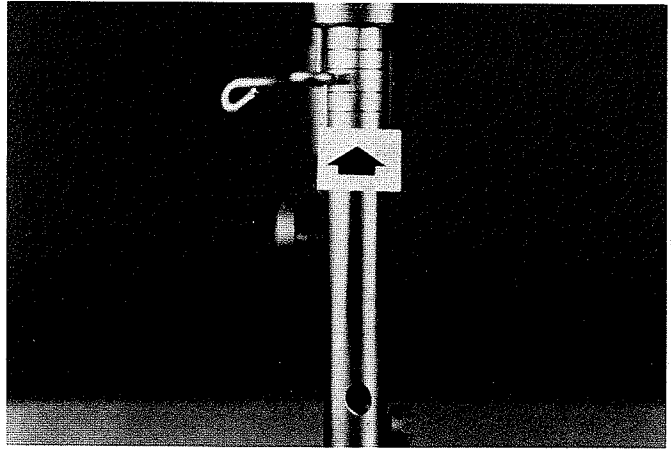


Fig. 31

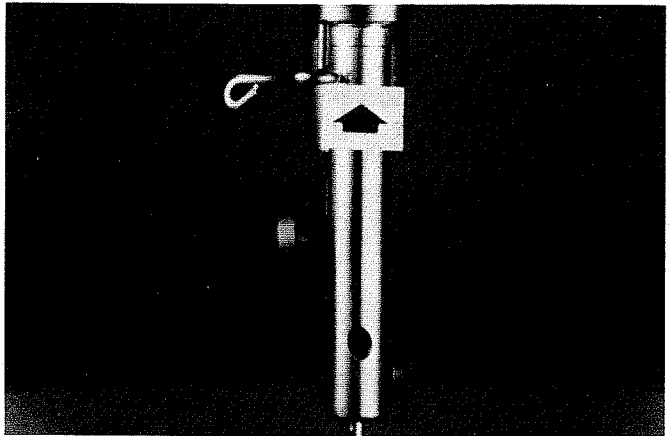
## NEEDLE HEIGHT AND POSTION

**Fig. 32** The needle bar on a 63400 Class machine has four timing lines: the top pair of lines used with a short blade needle, and the bottom pair of lines used with a long blade needle. The top line for each pair is used for setting the needle bar height, while the bottom line of each pair will be used for setting the hook timing.



**Fig. 32**

**Fig. 33** With the needle at the bottom of its travel, the top line of the pair used should be even with the bottom of the needle bar bushing. To make this adjustment, loosen the screw securing the needle bar and move the bar up or down as required. Once this needle height adjustment has been made, tighten the securing screw.



**Fig. 33**

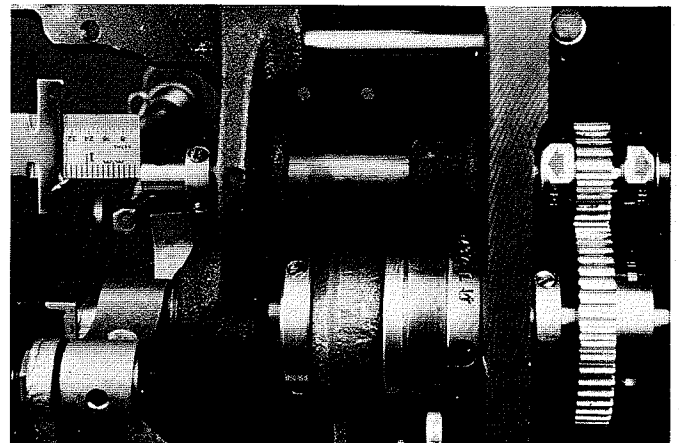
**Fig. 34** After the proper type and size of needle has been selected for the material to be sewn, insert a new needle into the needle bar making sure it is all the way up in its holder. Rotate the needle so its scarf side faces the rotary hook assembly and the groove side faces to the left. Secure the needle into its proper position by tightening the needle set screw.



**Fig. 34**

## HOOK SHAFT ADJUSTMENT

**Fig. 35** The hook shaft is positioned at the factory so a distance from the center of the needle to the end of the hook shaft is  $\frac{35}{64}$  of an inch or 13.9 mm. If this distance is not correct, oil flow to the raceway of the hook base might be restricted. This dimension should be taken from the needle to the hook shaft itself, and not to the end of the metering pin which has been inserted into the hook shaft. Adjustment is obtained by loosening the hook shaft pinion gear and thrust collar and moving the hook shaft.



**Fig. 35**

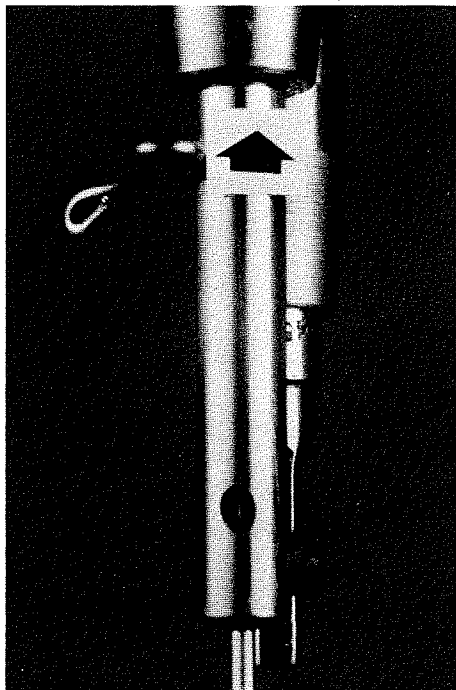


Fig. 36

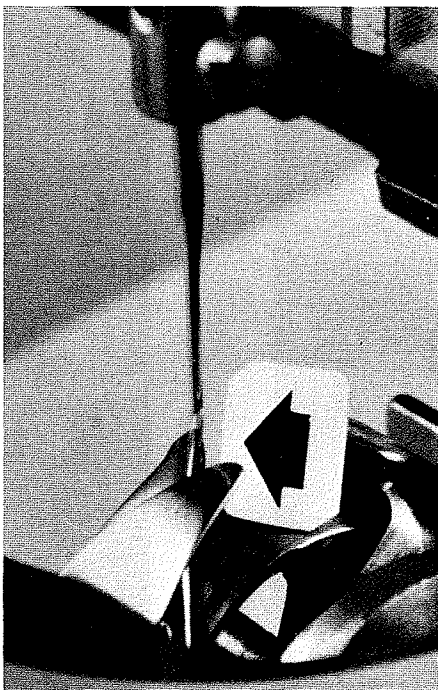


Fig. 37

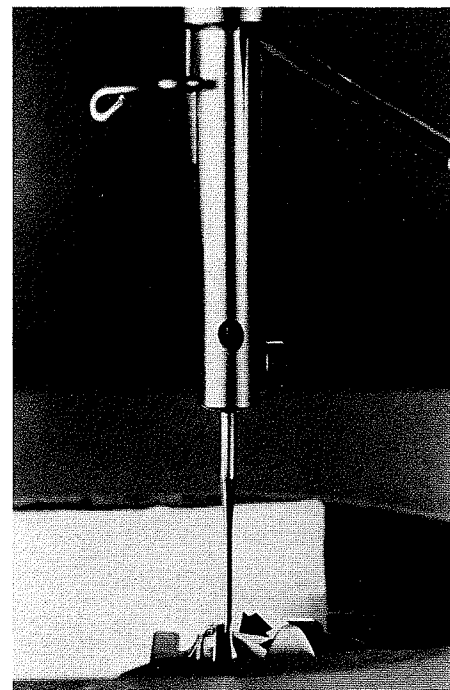


Fig. 38

### HOOK TIMING AND ADJUSTMENT

**Fig. 36** Install the hook onto the end of the hook shaft and then rotate the handwheel until the needle is at the bottom of its travel. Continue to rotate the handwheel until the hook timing line on the needle bar is even with the bottom of the needle bar bushing.

**Fig. 37** Maintaining this position of the needle bar and timing line, rotate the hook base on the hook shaft until the point of the hook is centered in the scarf of the needle front to back.

**Fig. 38** Now move the hook assembly left or right on the hook shaft until a minimum clearance is obtained between the hook point and the needle. Make sure the hook point does not deflect the needle because needle deflection greatly reduces the life of the hook and also creates more needle heat.

**Fig. 39** With the hook point positioned properly, tighten the set screw which is 180 degrees opposite the hook point. This screw provides the proper eccentricity between the hook base and basket to allow the needle loop to pass by the positioning finger with the least amount of resistance. Then make sure to tighten the other screw.

Move the hook stop collar against the hook base and secure it to the hook shaft. This collar will allow you to replace the hook if it has to be removed and still maintain the left and right adjustment of the hook point to the needle. This collar is **not** a thrust collar for the hook shaft and should not contact the bushing because it might create a pumping action pulling oil from the reservoir.

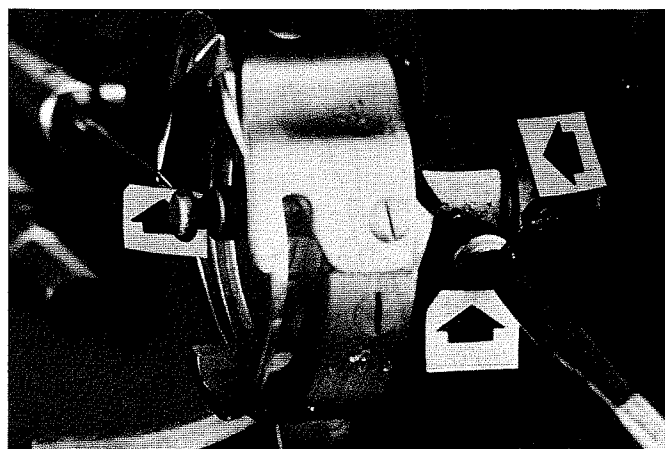


Fig. 39

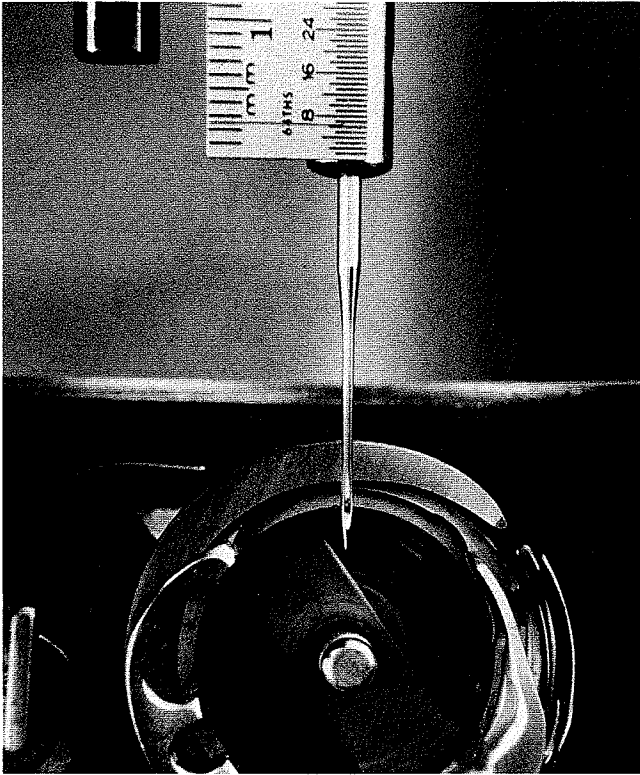


Fig. 40

### NEEDLE HEIGHT AND HOOK TIMING WITHOUT NEEDLE BAR TIMING LINES

**Fig. 40** If your machine does not have timing lines on the needle bar to set the needle height and hook timing, you may use the following procedure. Turn the handwheel until the needle is at the bottom of its travel.

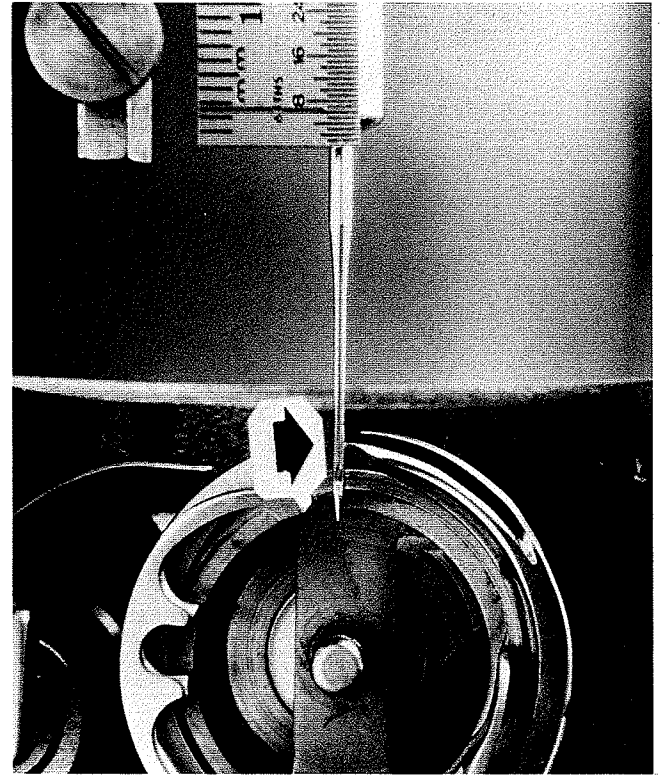


Fig. 41

**Fig. 41** Continue to rotate the handwheel in operating direction until the needle bar has risen  $\frac{3}{32}$  of an inch or 2.4 mm. Rotate the hook base on the hook shaft until the hook point is at the 12 o'clock position and centered in the needle front to back. The point of the hook should be approximately  $\frac{1}{32}$  of an inch or .8 mm above the eye of the needle. If this is not the case, loosen the needle bar clamp screw and move the needle bar to this position. The needle should never be set too low because this will cause the needle loop to be pinched by the needle guarding surface in the basket causing skipped stitches or thread breakage.

### NEEDLE GUARDING

**Fig. 42** The needle guard in a horizontal hook shaft lockstitch machine is the right edge of the needle slot in the basket. The purpose of the needle guard is to reduce the vibration of the needle and prevent it from being deflected into the path of the hook point. As the needle descends and enters the needle hole slot in the basket, the guarding surface should barely touch the needle as the needle reaches the bottom of its stroke. At this time, the vibration of the needle is removed in a similar manner as the vibration of a tuning fork is removed when it contacts a fixed object.

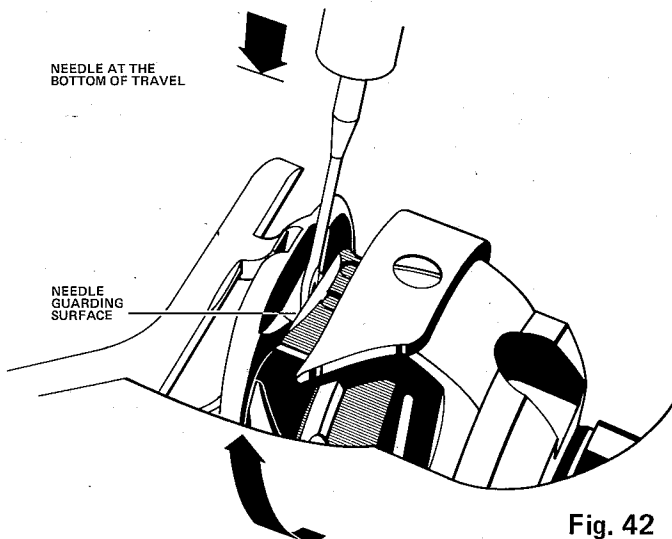


Fig. 42

**Fig. 43** When the needle rises and the hook point is getting ready to enter the scarf of the needle, the needle should be protected but not deflected by the needle guard. If the needle is being deflected at this time and the point of the hook has been set properly to the needle left or right, stock must be removed from the needle guarding surface. This alteration is best accomplished with a small diamond file<sup>1</sup> which fits into the needle slot in the basket. Keep in mind however, that metal removed can never be replaced. Alteration may be accomplished without removing the basket however, care must be taken to prevent filings from entering the hook raceway.

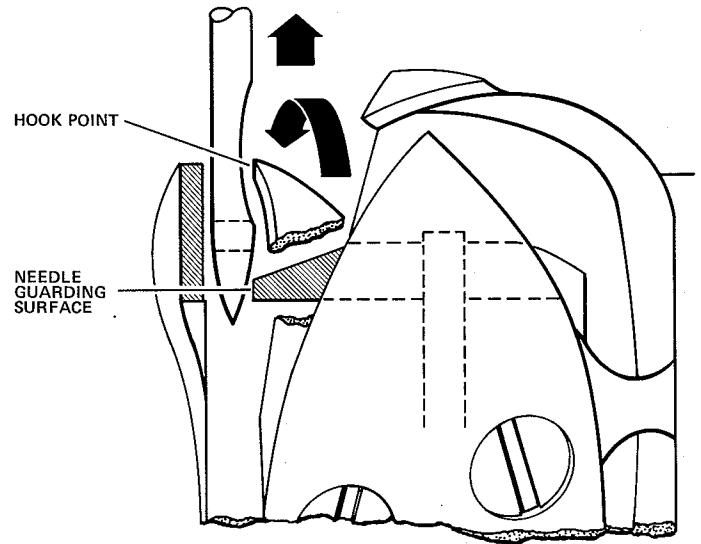


Fig. 43

## POSITIONING FINGER

**Fig. 44** The positioning finger is used to hold the basket in its proper position and prevent it from rotating with the hook base. The positioning finger should be positioned so that a clearance of at least  $\frac{1}{32}$  of an inch or .8mm is obtained between the positioning finger recess in the basket and the finger. This clearance is necessary to allow the needle thread to move past the finger with the least amount of resistance during the stitch formation.

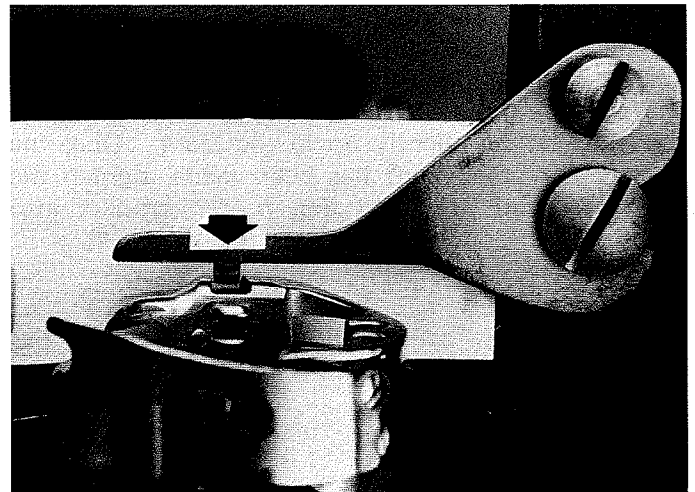


Fig. 44

## FEED DOG

**Fig. 45** With the feed dog already attached to the feed dog holder, assemble the holder into the holder support which is attached to the feed bar. The holder support has a height adjusting screw for adjusting the height of the feed dog. When removing the feed dog, it is recommended to remove the feed dog and holder as an assembly. This eliminates having to re-adjust the feed dog front or back when replacing it into the machine.

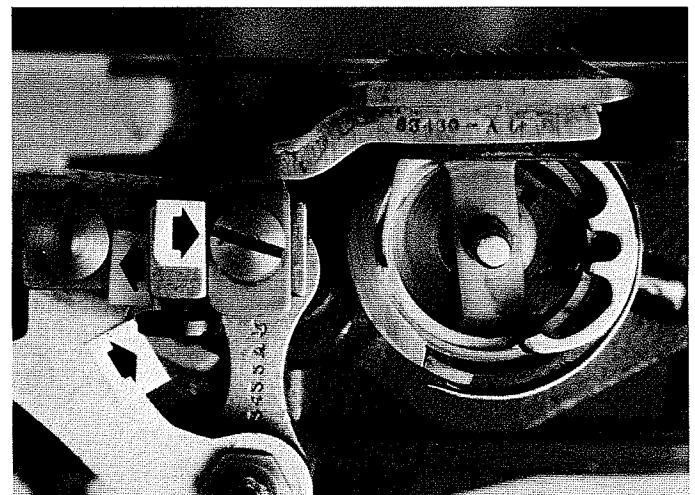
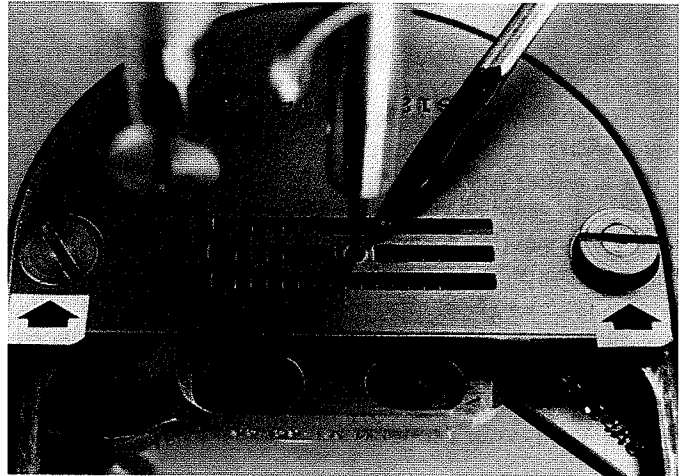


Fig. 45

<sup>1</sup>TTC-60 – Diamond File

## NEEDLE HOLE – NEEDLE RELATIONSHIP

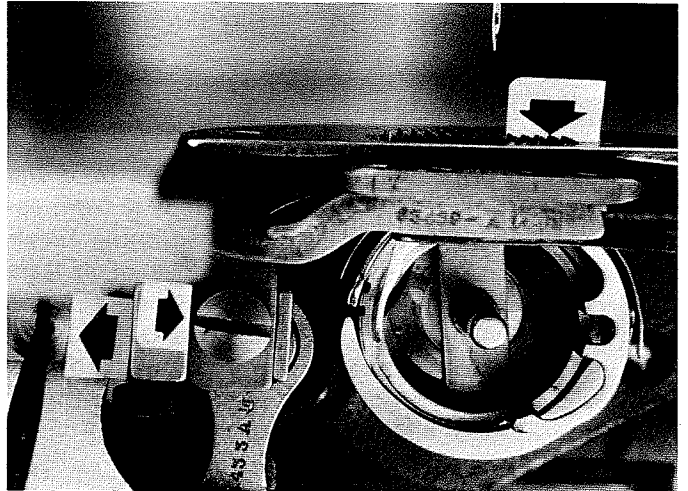
**Fig. 46** Install the throat plate to the casting with the two fillister head screws. These screws allow the throat plate to be moved so the needle centers in the needle hole of the throat plate. Generally the diameter of the needle hole in the throat plate should be approximately twice the diameter of the needle diameter. For example, a size .032 needle hole would require a size .063 needle hole in the throat plate. Common sizes of needle holes in throat plates are: .053", .063", .073", .083", and .093". If the needle hole in the throat plate is too small, excessive thread breakage may occur. If the needle hole is too large, skipped stitches and/or puckering may result from flagging.



**Fig. 46**

## FEED TILT ADJUSTMENT

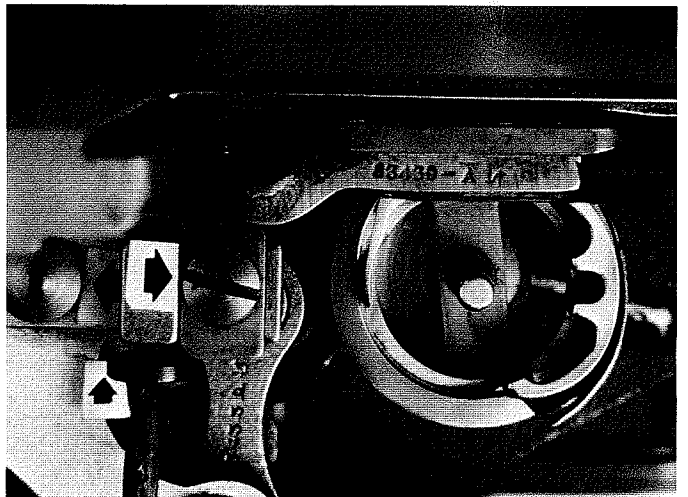
**Fig. 47** In this view, the feed dog is tilted down slightly in the front. Leveling of the feed dog with the top of the throat plate can be accomplished by loosening the feed dog holder clamp screw and the angle adjusting screw indicated by the arrows, and moving the feed dog holder slightly up in the front. Once the correct tilt adjustment has been made, tighten the screw securing the feed dog holder support into position.



**Fig. 47**

## FEED DOG HEIGHT

**Fig. 48** With the feed dog at its highest point of travel, the feed dog teeth should extend above the throat plate approximately one full tooth. The feed dog can be raised by turning the adjusting screw clockwise. Once this adjustment has been made, remember to tighten the feed dog holder screw.

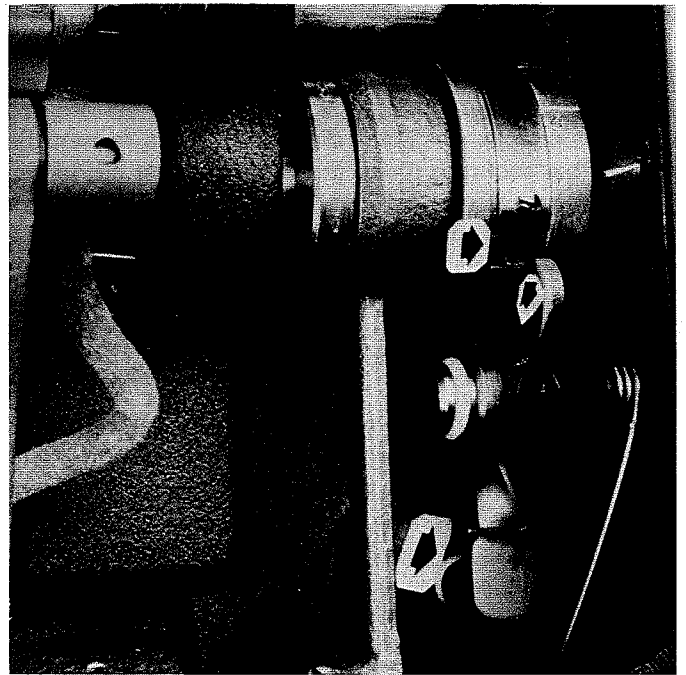


**Fig. 48**



## FEED TRAVEL ADJUSTMENT

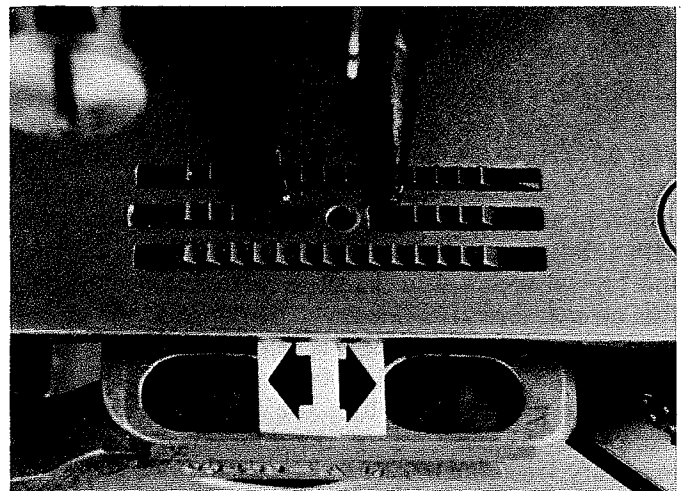
**Fig. 49** The feed travel which determines the stitches per inch (S.P.I.) is adjustable on 63400 machines by depressing a button on the cloth plate. As the hand-wheel is turned, a pawl will fall into a notch in the Feed Drive Eccentric continuing to rotate the hand-wheel in operating direction, when the pawl is engaged in the notch, will increase the stitch length, reversing the handwheel rotation will shorten the stitch. An indicator is provided near the handwheel to give the operator an idea of approximately how many stitches per inch the machine is set at. Exact adjustment will have to be measured on the material. The indicator is adjustable to conform to S.P.I.



**Fig. 49**

## FEED ADJUSTMENT FRONT OR BACK

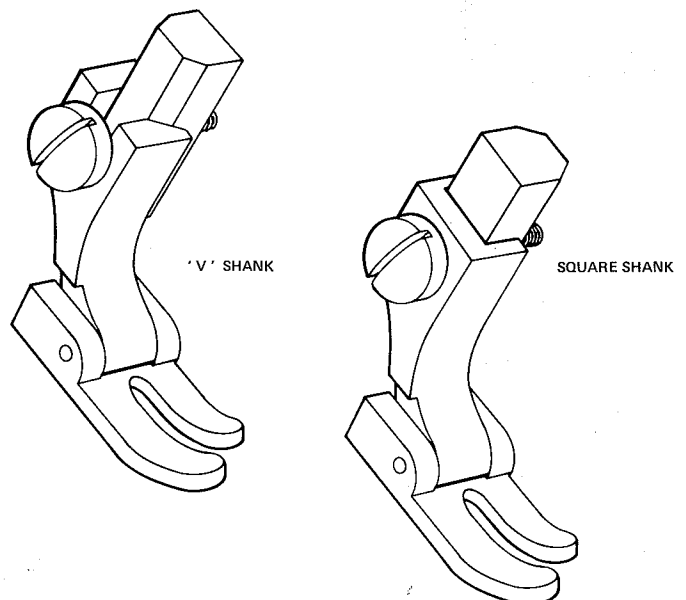
**Fig. 50** Adjustment of the feed dog front to back is accomplished by loosening the two screws that secure the feed dog to the feed holder. The feed travel should be centered in the slots of the throat plate. When removing the feed dog, it is recommended to remove the feed dog holder as an assembly. This eliminates having to readjust the feed dog front or back when replacing it into the machine.



**Fig. 50**

## PRESSER FOOT

**Fig. 51** Presser feet used on 63400 machines have a "V" shaped cut out in the shank which matches the "V" shape of the presser bar. Some presser feet which have square shaped cut outs can be used on 63400 machines by rotating the universal presser bar 180 degrees. This side of the presser bar was designed for Singer style presser feet.

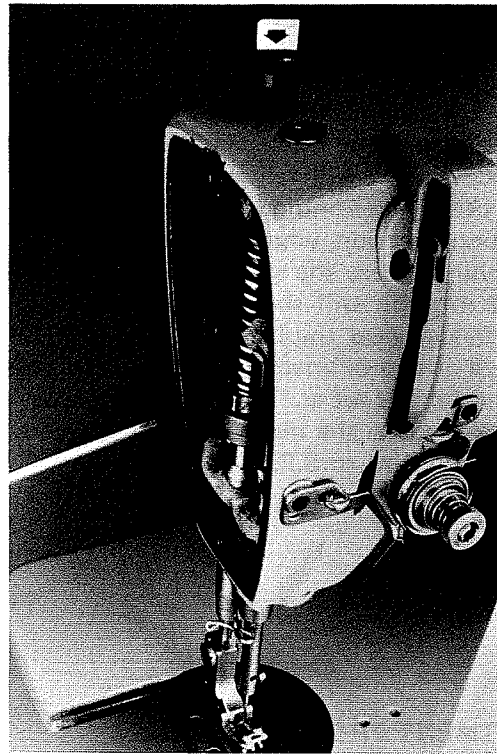


**Fig. 51**

## PRESSER FOOT ALIGNMENT AND PRESSURE

**Fig. 52** After the presser foot has been attached to the presser bar, the presser foot should be aligned with the needle. To make this adjustment, loosen the presser bar securing screw in the presser bar guide and rotate the presser bar. Making sure that the presser foot is resting flat on the throat plate, tighten the securing screw holding the presser bar and presser foot into position. A clearance of approximately 1/16 inch or 1.6mm should be maintained between the presser bar guide and the presser bar connection.

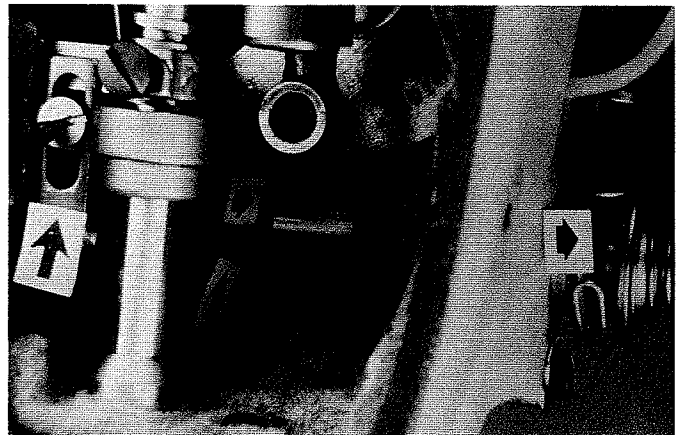
Pressure applied on the material by the presser foot is adjusted by the pressure spring regulator. Generally the least amount of tension required to feed the material uniformly over the entire seam is recommended. Minimum pressure reduces puckering, ply mismatching, chain cutting, and parts wear.



**Fig. 52**

## MANUAL TENSION RELEASE

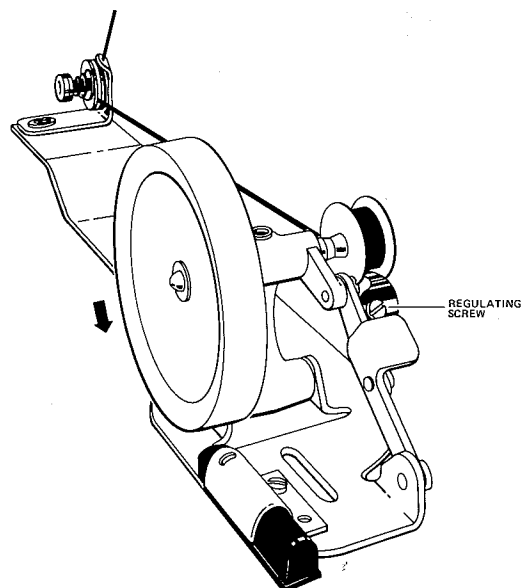
**Fig. 53** The opening of the tension discs is tied to the travel of the knee press by a Tension Release Cam which is attached to the presser bar connection. This cam is adjustable up or down to determine how high the presser foot has to be raised before the tension on the needle thread is released. The higher the cam is set, the sooner the tension is released. When manual back tacking is required, the tension must NOT be released as the operator lifts the foot and moves the material. Adjustment of the Tension Release Cam may vary from operator to operator.



**Fig. 53**

## BOBBIN WINDER

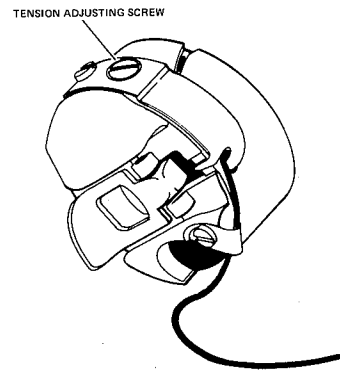
**Fig. 54** The bobbin winder should be secured to the table top so that its pulley will be located directly in front of the machine belt. The base of the winder has two elongated attaching screw holes which allow the mechanism to be set closer or farther away from the belt as needed. The pulley of the winder, when in operation, should exert only enough pressure against the belt to wind the bobbin. The bobbin winder tension assembly should have only enough pressure so the thread winds back and forth evenly on the bobbin. The regulating screw should be adjusted so that when the bobbin is full, it will automatically disengage the pulley.



**Fig. 54**

## BOBBIN THREADING AND TENSION

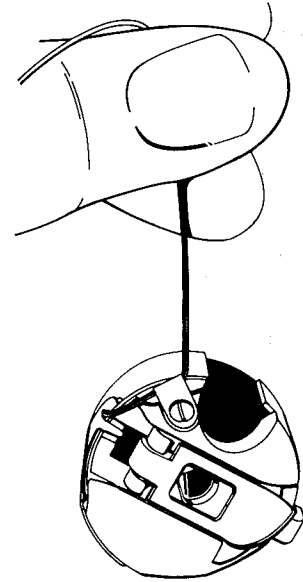
**Fig. 55** Place the bobbin into the bobbin case bringing the thread under the tension spring and into the eyelet. Tension is adjusted by turning the tension screw on the bobbin case clockwise for more tension or counter-clockwise for less tension. Usually the bobbin thread requires only enough tension so that thread is pulled from the bobbin uniformly.



**Fig. 55**

**Fig. 56** One way of checking this tension adjustment is by holding the bobbin thread so the bobbin case hangs in mid air, and giving a slight jerking motion on the thread. The weight of the bobbin case should cause the thread to be pulled through the tension spring but then stop again. If this is not happening, adjust the tension screw to meet this condition.

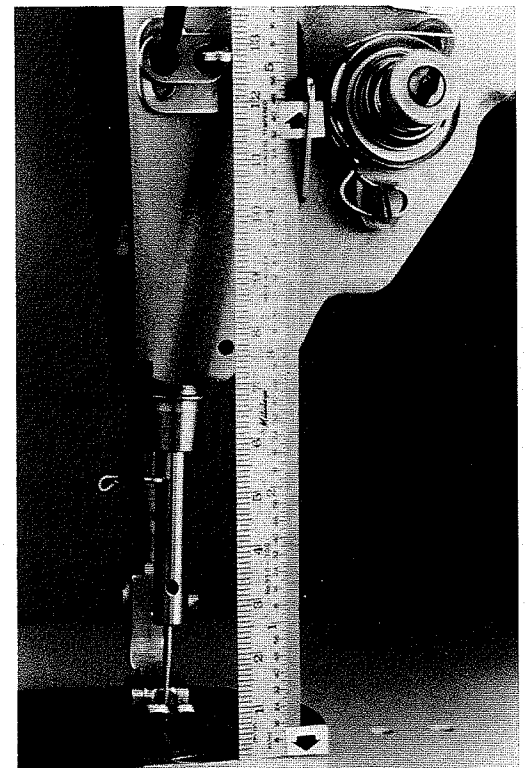
Install the bobbin case with the bobbin into the hook making sure the latch locks into the recess of the spindle.



**Fig. 56**

## GOOSENECK POSITION

**Fig. 57** The gooseneck should be positioned so a dimension of 4-3/4 inches or 12.1 cm is obtained from its underside to the cloth plate. On machines where the gooseneck is attached to the presser bar, the presser foot must sit flat against the throat plate when taking this measurement.

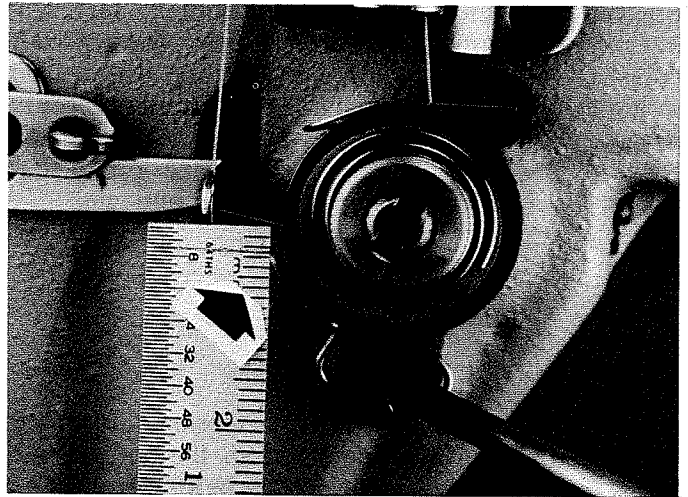


**Fig. 57**

## SNUBBER POSITION

**Fig. 58** The snubber is the eyelet located directly below the tension assembly which maintains a consistent path for the needle thread to run through the tension discs, regardless of where the check spring is. It therefore helps to maintain more uniform needle thread tension even at very high sewing speeds. The snubber should be positioned approximately  $\frac{3}{32}$  of an inch or 2.4mm below the needle thread running from the tension assembly to the gooseneck. It should be positioned close to the tension discs but not touching them.

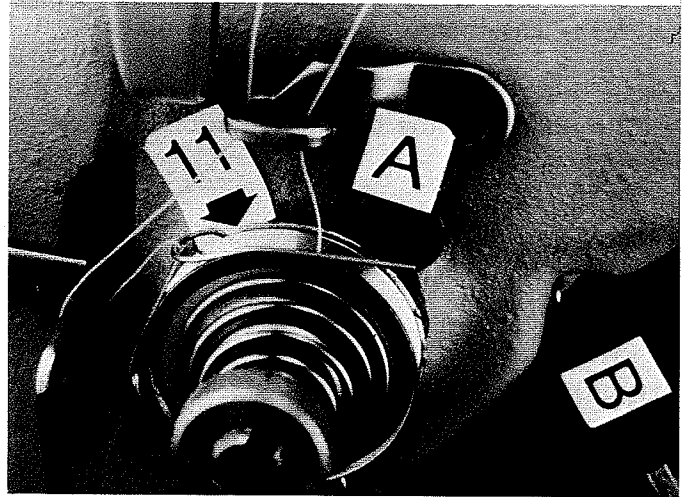
Fig. 58



## CHECK SPRING POSITION AND TENSION

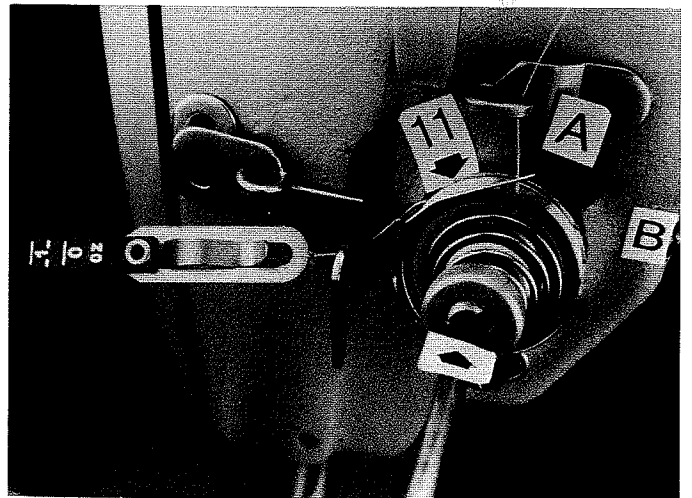
**Fig. 59** When installing the tension assembly into the casting, it should be pushed all the way in until it contacts stop screw 'A'. The tension assembly should also be rotated until the check spring stop is at approximately the 11 o'clock position. Screw 'B' secures the tension assembly into the casting.

Fig. 59



**Fig. 60** When the check spring returns toward its stop after being depressed, it should move back with a positive action. The amount of tension on the check spring should be about 1 to  $1\frac{1}{2}$  ounces, depending on the thread and material to be sewn. To change the amount of tension on the check spring, insert a screw driver into the tension post slot and turn the post without turning the entire assembly. Clockwise increases the tension and counter-clockwise decreases the tension. Screw 'B' does not have to be loosened to make this adjustment.

Fig. 60



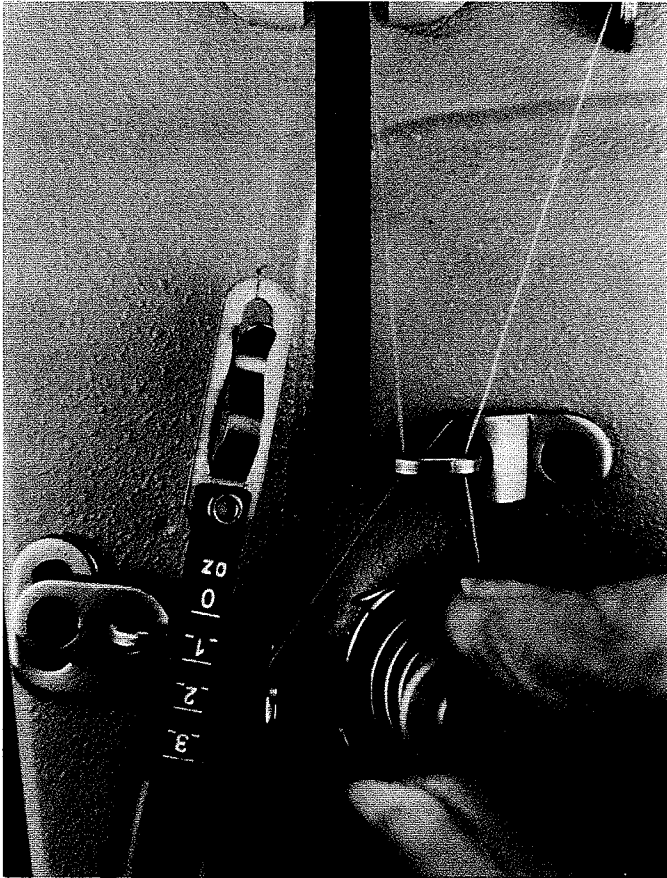


Fig. 61

Fig. 61 Now thread the machine making sure the needle thread runs through all of the eyelets properly. Tension on the needle thread is adjusted by the tension nut on the end of the tension post. By turning the tension nut on the post clockwise, tension on the needle thread is increased pulling the needle thread up closer to the top side of the material. By turning the tension nut counterclockwise, the tension on the needle thread is decreased. A minimum amount of needle thread tension is desired to set the stitch in the middle of the material. Approximately  $3\frac{1}{2}$  ounces or 100 grams of tension is normally needed to obtain a balanced stitch, however, the actual amount of tension is dependent on the thread and material to be sewn.

Fig. 63 Sew on the material again and observe the appearance of the stitch. The stitch should appear the same on both sides of the material with every stitch looking exactly the same. It might be necessary to adjust the needle thread tension slightly to get this stitch appearance.

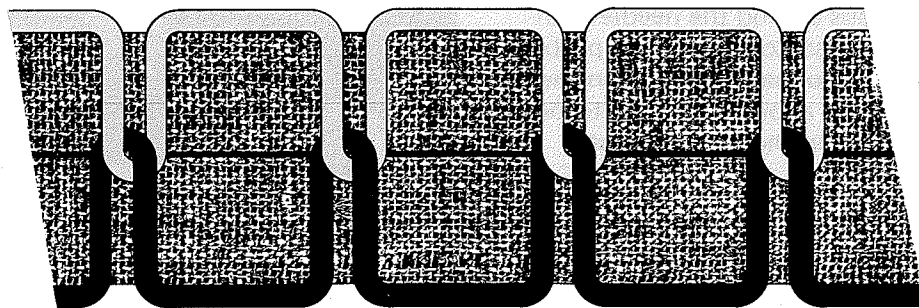


Fig. 63

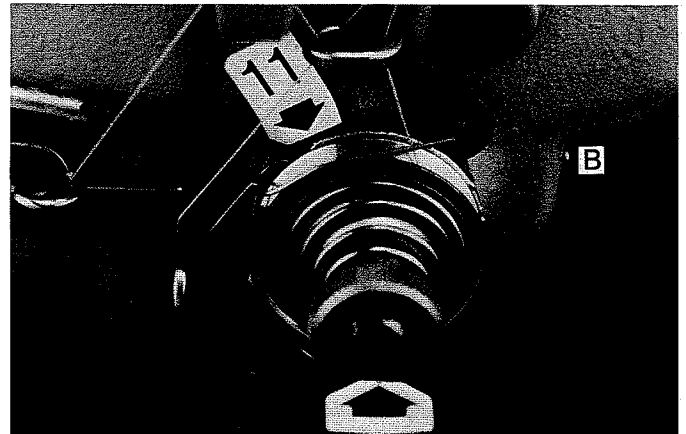
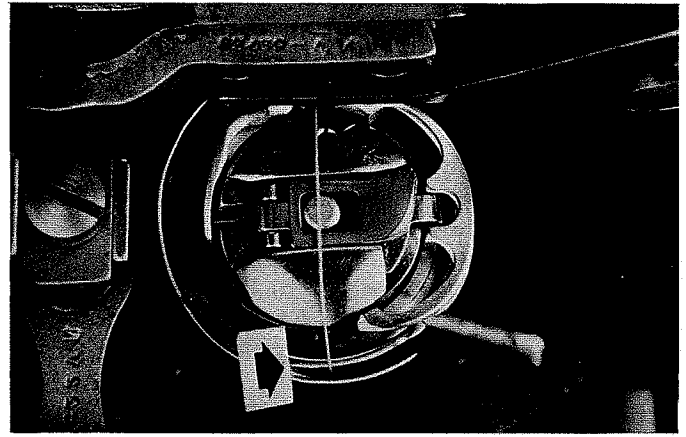


Fig. 62

Fig. 62 With the machine threaded properly, sew several inches of material and then turn the handwheel by hand to observe the stitch formation. As the needle thread loop crosses the 6 o'clock position of the hook, the check spring should wink or move from its stop. If the check spring does not leave its stop at precisely this position of the needle thread loop, loosen screw 'B' and turn the entire tension assembly until this condition is obtained. It might be necessary to sew a few inches between adjustments to get an accurate setting. The check spring adjustment is very important.

## TECHNICAL DATA

### CHAINING

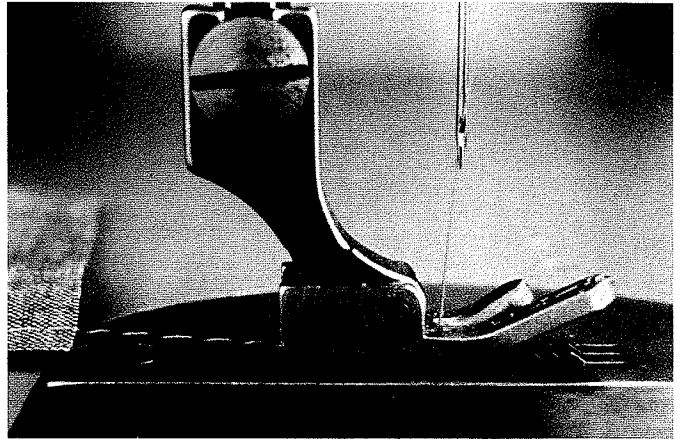
**Fig. 64** Chaining, which is the forming of stitches without material, is very common on operations where the operator does not have to start and stop in the middle of the material. Chaining on and off a seam does not require the operator to lift the presser foot reducing the time it takes to do the job. In order for a lockstitch machine to chain efficiently, the machine must be adjusted properly, and it must have the correct sewing combination. The term sewing combination refers to the presser foot, feed dog, and throat plate.

**Fig. 65** Chaining requires that the presser foot clamp the chain against the throat plate as the feed dog descends below the plate. If not, the chain will be pulled down through the needle hole resulting in thread breakage or skipped stitches. The throat plate surface located directly behind the needle hole is called the 'land.' The 'land' must be long enough to insure sufficient clamping of the chain between the presser foot and the throat plate.

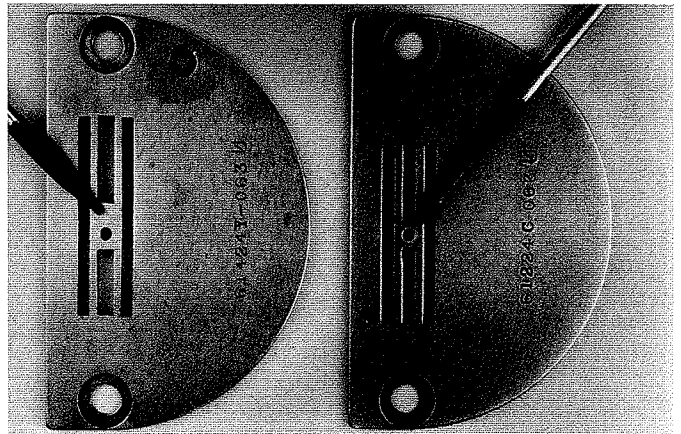
**Fig. 66** To check the clamping action of the chain by the presser foot and throat plate, place a single strand of thread under the presser foot and over the land of the throat plate. When pulling on the thread from front to back, the thread should be held firmly into position, until the feed dog rises and moves it to the rear of the machine.

**Fig. 67** Sometimes the feed dog teeth may be too sharp causing the chain to be cut. Stoning the center row of teeth to a slight radius behind the needle with a triangle stone is recommended to reduce this problem. Be especially careful not to make a groove in the feed dog teeth since this will allow the chain to be pulled into the needle hole when the feed dog rises.

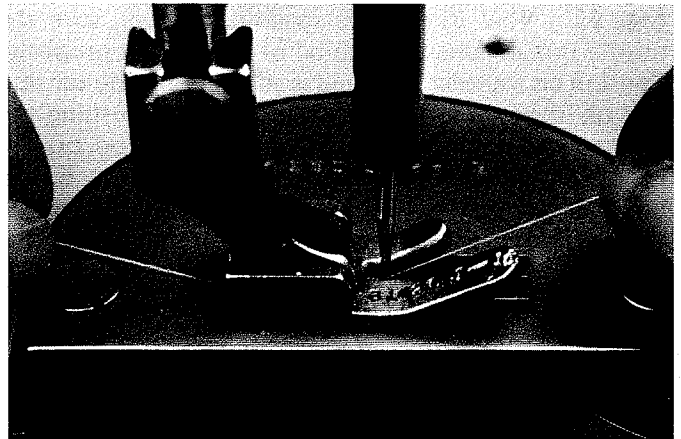
**Fig. 64**



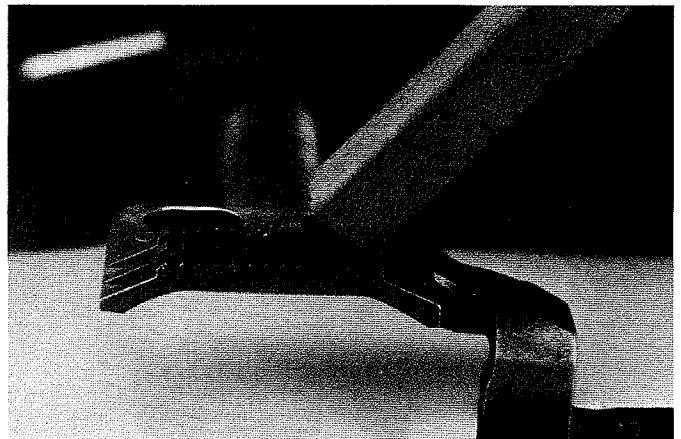
**Fig. 65**



**Fig. 66**



**Fig. 67**

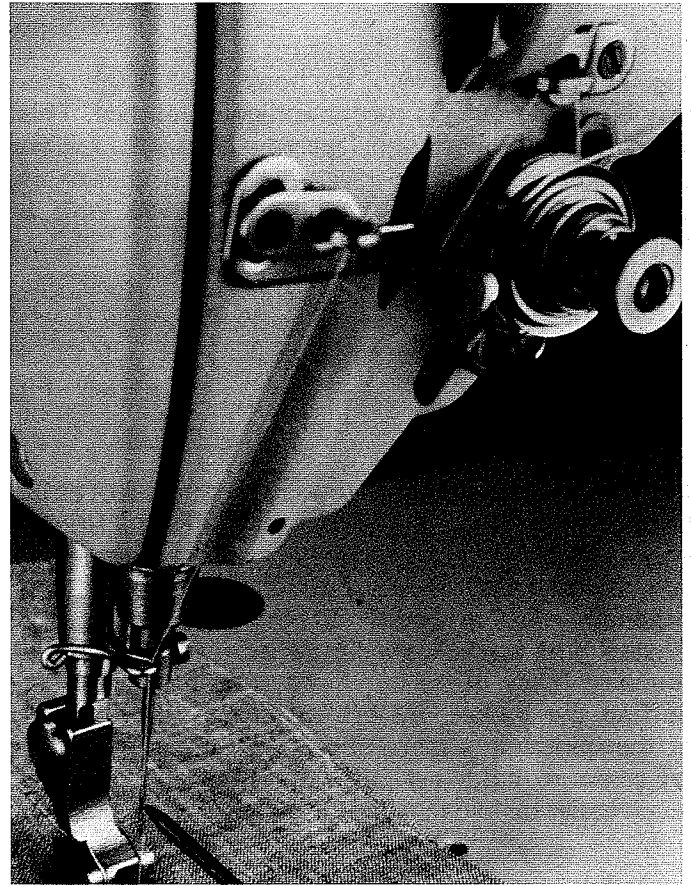


## THREAD CONTACT SURFACES

**Fig. 68** Approximately 3½ inches or 8.9cm of needle thread is carried below the material and around the basket during the formation of each stitch, even though only one stitch length is consumed. Therefore, the needle thread on a lockstitch machine is subject to very severe handling. If we made a mark on the needle thread directly above the needle eye when the take-up was at the bottom of its travel, before this mark or any point of thread is sewn into the seam it will pass back and forth through the eye of the needle many times. The actual number of times would depend on the stitch length and the thickness of material being sewn. At 10 s.p.i., a point of thread would pass through the eye approximately 70 times before being sewn into the seam. At 8 s.p.i., a point of thread would pass through the eye approximately 56 times before it is sewn into the seam.

(S.P.I. X inches per take-up travel up and down = approximate number of times.)

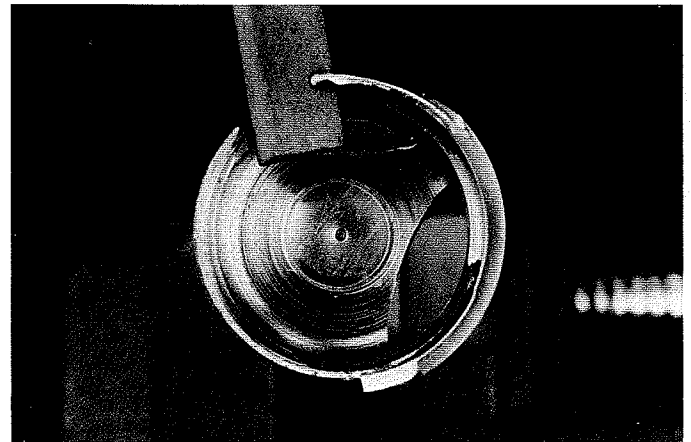
**Fig. 68**



All thread contact surfaces within a rotary hook assembly must be highly polished to avoid thread breakage problems. When inspecting a hook for nicks or burrs, attention should especially be given to the following:

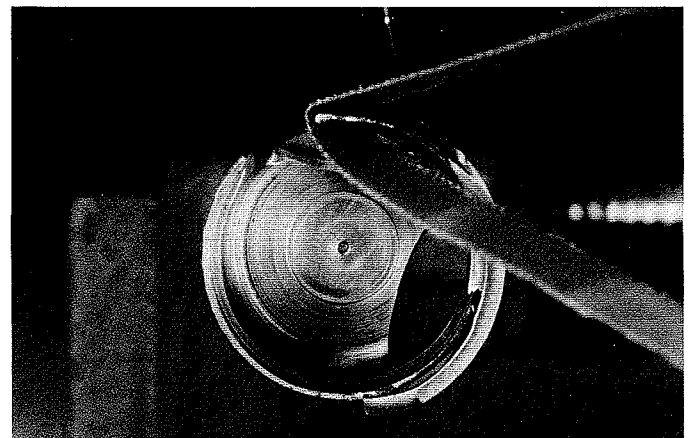
**Fig. 69** If the hook point has been damaged, usually it can be restored to its original shape. Always work on the back or angled side of the hook point to recreate the original surface. After reshaping the hook point, polish the hook point with a very fine emery cloth.

**Fig. 69**

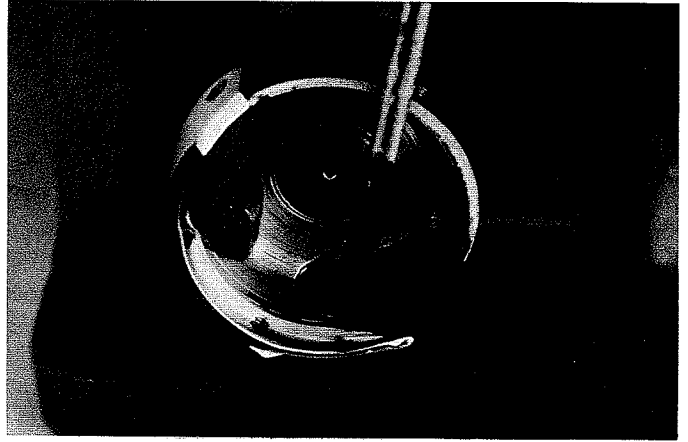


**Fig. 70** Care must be taken to prevent any accidental altering of the upper edges of the thread stop. If the top edge of the thread stop is rounded off, the thread will jam between the thread deflector and the thread stop causing thread breakage.

**Fig. 70**

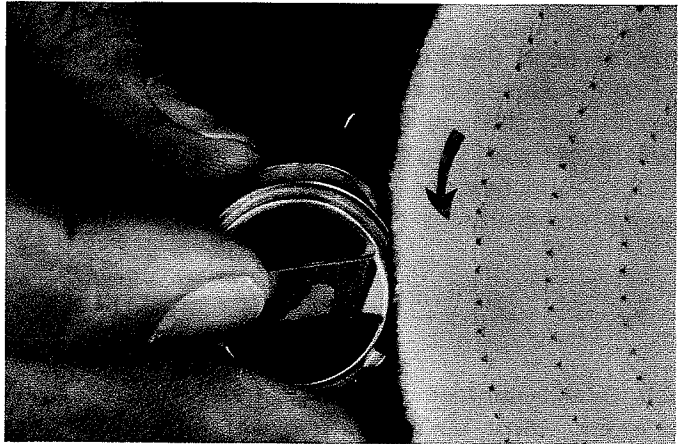


**Fig. 71** Check the area of the hook point at the raceway entrance, making sure it is highly polished. This area must be smooth and tapered to allow the rail on the basket to enter the raceway without chatter. If burrs exist, they can usually be removed with a Handee Grinder polishing wheel.



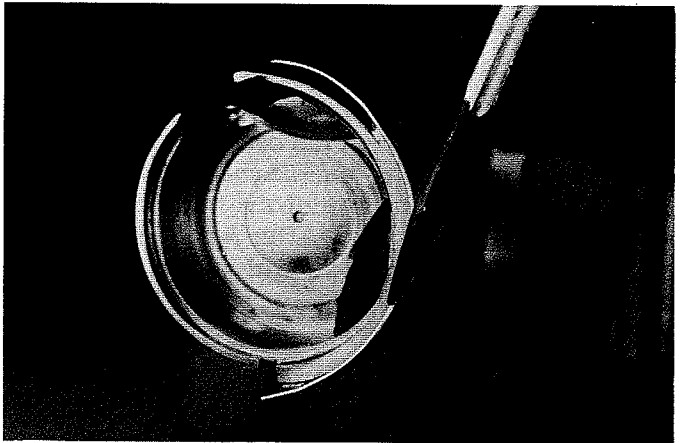
**Fig. 71**

**Fig. 72** The thread detainer point of the basket must be smooth and retain the same angle for its full height. If not, the thread will ride over the top of the rail and jam between the rail and raceway of the hook. Occasionally it is necessary to buff the rail on the basket. Always buff away from the thread retainer to avoid rounding it off. It is a good idea to make a holder for buffing the basket, by drilling a hole the diameter of the spindle in a piece of drill rod and using a small set screw to hold it in place. This makes the basket much easier to hold in a vice or by hand while buffing.



**Fig. 72**

**Fig. 73** Check for nicks and burrs along the edge of the thread deflector. Since it is this part that lifts the needle loop over the bobbin case and basket, any sharp edges will cause thread breakage.



**Fig. 73**

To correct a needle thread breakage problem, the following sequence is recommended:

1. Check the threading
2. Check the needle
  - a. Is it bent?
  - b. Is the point blunt?
  - c. Is it the correct type and size?
  - d. Is the eye sharp?
3. Is the tension too great?
  - a. On the tension discs
  - b. On the check spring
  - c. On the bobbin thread
4. Is the check spring height correct?
5. Is the gooseneck position correct?
6. Is the needle — needle hole relationship correct?
7. Is the hook timing correct?
8. Is the positioning finger too close?
9. Is the feed timing correct?
10. Are there any burrs on thread contact surfaces?



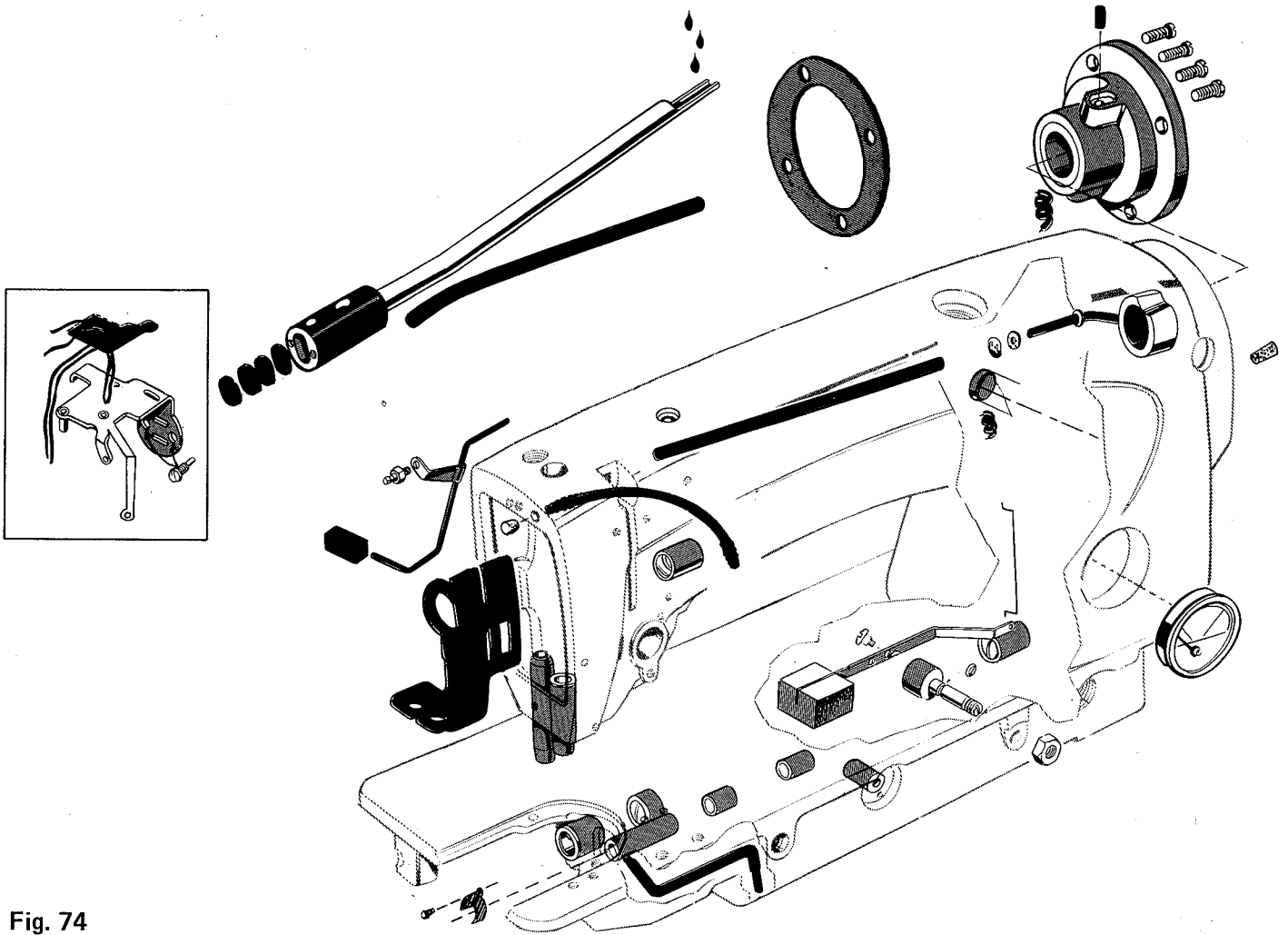


Fig. 74

**Fig. 74** The lubrication system used in a 63400 machine is divided into two classifications — Supply and Return. Oil is supplied to the required surfaces through a splash and wick system. Oil is returned to the reservoir by an oil siphon assembly. A delicate balance must be maintained between supplying enough oil to bearing surfaces to increase the life of the mechanisms, but also return any excess of oil which could possibly soil the material being sewn.

Oil is stored in a completely enclosed reservoir with an oil gauge to indicate the oil level. As the machine begins to rotate, the drive belt splashes the oil inside the casting. Oil then drips from a lug in the top of the casting into the collector of the head oil supply line. The wick inside this supply line transfers the oil to the Head Oiler Wick Assembly which lubricates the take-up, needle bar, presser bar, and all linkages in the head. The excess oil which collects in the head is then transferred back to the reservoir by the oil siphon system.

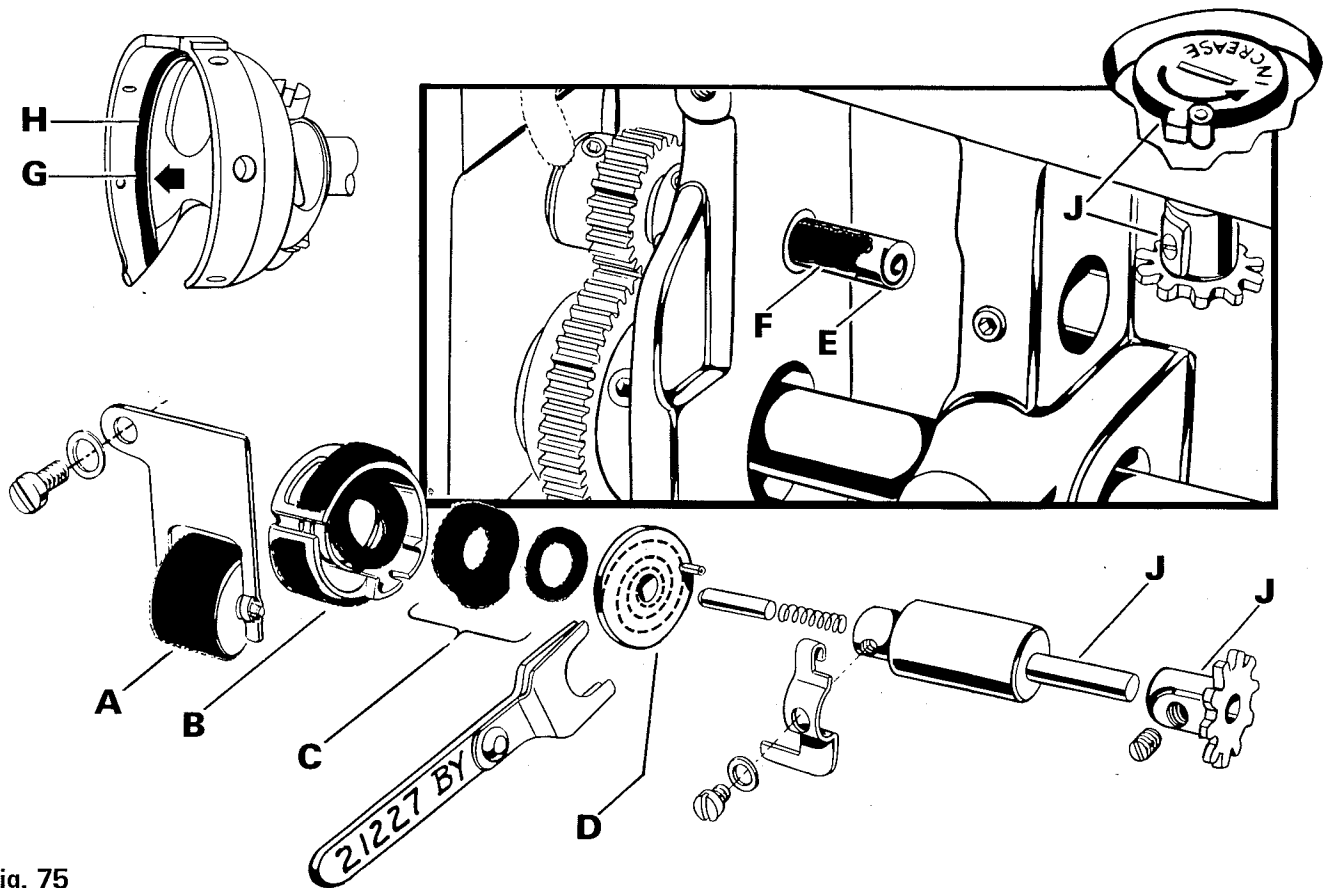


Fig. 75

**Fig. 75** Because the rotary hook in lockstitch machines rotates at such high speeds, lubrication between the raceway and the rail of the basket is very critical. On 63400 machines, this is accomplished through a pump and wick system.

The feed roller (A) is partially submerged in the oil of the main reservoir. Oil is transferred from the feed roller to the metering cup (B) by capillary action. The felt on the outer circumference of the metering cup carries the oil around the metering cup and then inside the cup to the oil supply and air seal felts (B&C). Oil moves through these felts to the pump disc (D). The pump disc is pressed against the end of the hook shaft (E). There is a spiral groove cut into both the face of the pump disc and the end of the hook shaft. As the hook shaft turns, a pumping action is created supplying oil into the hook shaft.

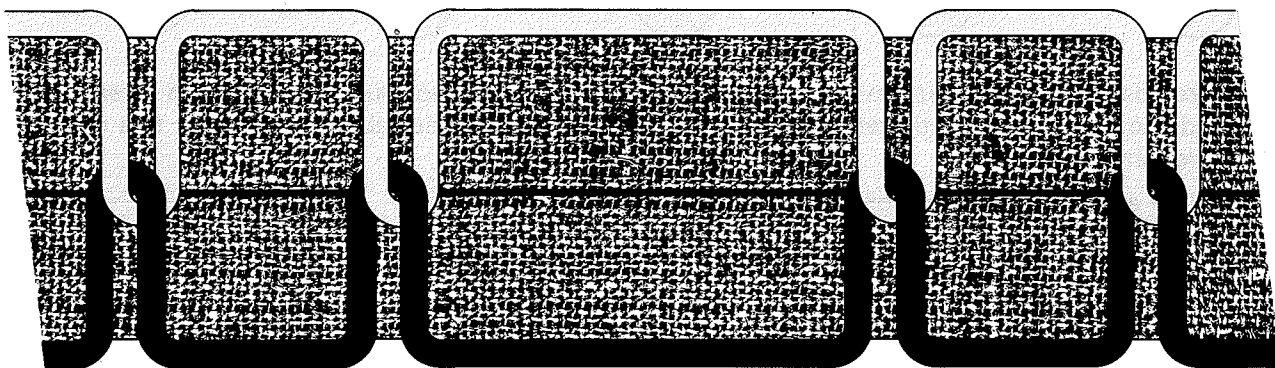
A wick assembly (F) inside the hook shaft carries the oil to the other end of the hook shaft where it is emitted into the channel (G) within the hook base. This oil moves up through the oil passage drilled into the base and exits into the raceway (H).

The amount of oil that reaches the hook is adjustable to compensate for varying sewing conditions. A machine running at high speeds and for longer periods of time would require more lubrication than a machine sewing short operations where the speed is limited by the handling capabilities of the operator. This adjustment is made by turning the oil control Adjusting Shaft (J) which is accessible on the front of the casting. By turning this Adjusting Shaft, the position of the metering cup in relation to the feed roller is changed. If the contact point of the feed roller and metering cup is at the position where the felt enters the metering cup, the oil supply will be at its greatest. If the contact point is at the very beginning of the felt, the oil must move the full circumference of the metering cup prior to entering inside the cup supplying less oil to the hook. To check the oil flow to the hook, hold a piece of paper below the hook, and run the machine for 10 to 15 seconds. A very fine spray of oil should be noted on the paper. An increase of oil flow should be instantly noticeable, a decrease requires more time.

## SKIPPED AND IMPROPER STITCHES

If the machine is adjusted as previously described, a proper 301 stitch formation should be achieved. However, at times, skipped or improper stitches may result and we must be able to identify and correct the problem as soon as possible.

**Fig. 76** A skipped stitch on a 301 stitch machine may be identified from both sides of the fabric. An appearance of double the length of the regular stitch results. If two stitches are skipped successively the appearance is that of a stitch three times the normal length.

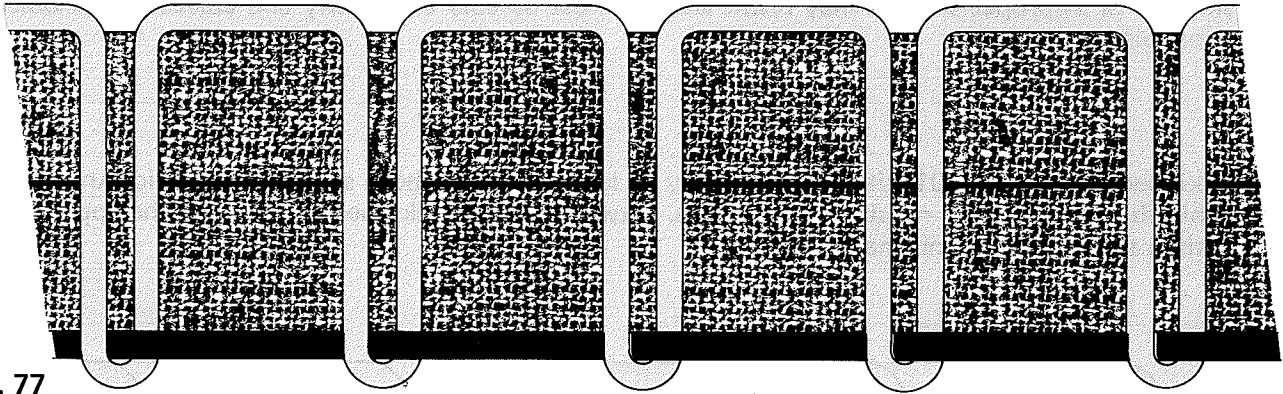


**Fig. 76**

A skipped stitch on a 301 Lockstitch machine occurs when the hook point misses the needle thread loop. To correct this problem, use the following sequence:

1. Check the threading — from the cone to the needle
2. Check the needle
  - a. Is it bent?
  - b. Is it the proper size for thread being used?
  - c. Is it the proper type for material being sewn?
  - d. Is it positioned properly?
3. Is the needle height correct in relation to the hook point?
4. Is hook timing correct?
5. Is the distance between the hook and needle correct?
6. Is the needle guard correct for the size needle being used?
7. Is the material flagging? Check for too large a hole in the presser foot or throat plate
8. Is the feed timing correct?

**Fig. 77** A 301 stitch is set properly when the needle thread and bobbin thread interlock in the center of the material or seam thickness. If this condition is not met, a malformed 301 stitch is produced.

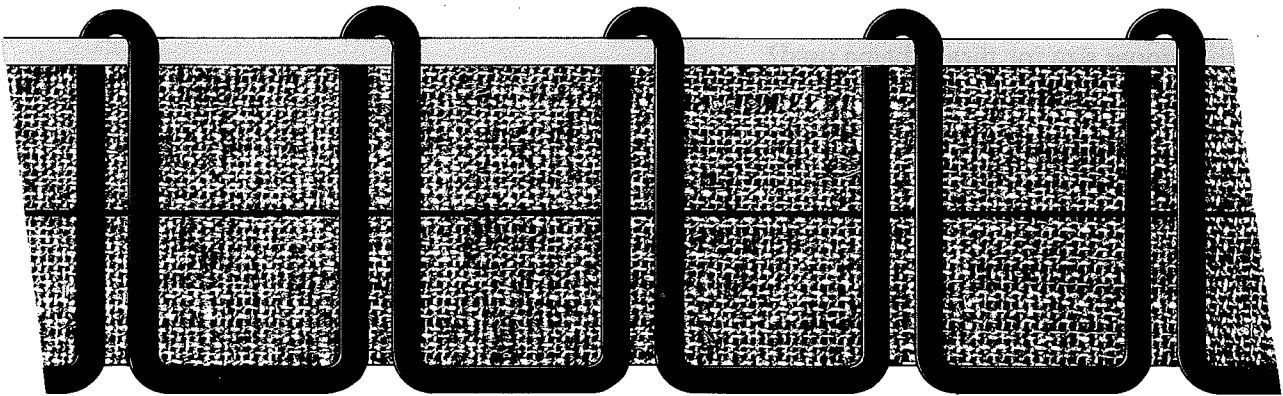


**Fig. 77**

If the loops are observed on the bottom of the seam, the needle thread is not pulling the bobbin thread up into the fabric and the needle loop is therefore visible on the underside of the fabric. To correct this condition, check the following:

- a. Is the threading correct?
- b. Is the needle the proper type and size?
- c. Is the bobbin thread tension too tight? Is it threaded correctly?
- d. Is the check spring too low? Is there too little check spring tension?
- e. Is the gooseneck setting correct?
- f. Is the needle thread tension too loose?
- g. Is the positioning finger too close?
- h. Is the needle height-hook timing correct?
- i. Is the feed timing correct?

**Fig. 78** If the loops are observed on the top of the seam, the needle thread is pulling the bobbin thread through to the top side of the seam and the bobbin thread is visible on the top of the fabric. To correct this condition check:



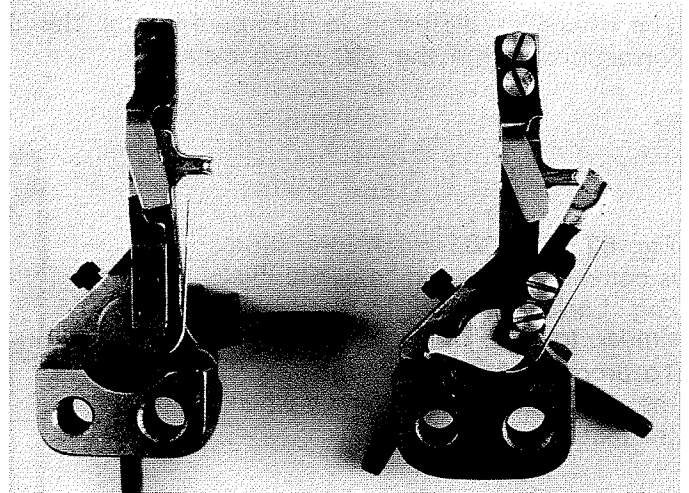
**Fig. 78**

- a. Is the threading correct?
- b. Is the needle the proper type and size?
- c. Is the needle thread tension too tight?
- d. Is the check spring position and tension correct?
- e. Is the gooseneck setting correct?
- f. Is the bobbin thread tension too loose? Is it threaded correctly?

## THREAD TRIMMERS

**Fig. 79** Many lockstitch machines are equipped with top and bottom thread trimmers to increase the efficiency of an operation where starting or stopping in the middle of the material is necessary. The Union Special top and bottom thread trimmer referred to as "Klipp-It" thread trimmer is shown here in its closed and open positions. A needle positioner is required when using the "Klipp-It" thread trimmer to bring the needle to an **UP POSITION** when the knife is trimming the threads below the plate. This position action also assists the operator in removing the material from the machine.

**Fig. 79**



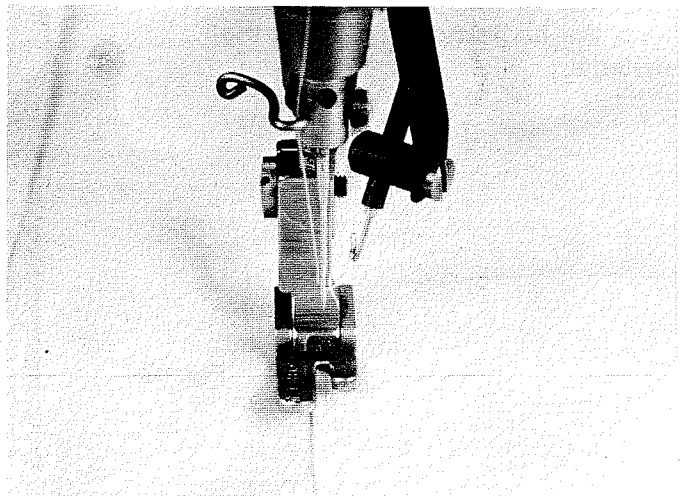
**Fig. 80** The following is a basic sequence of what takes place as the operator reaches the end of a seam. When the operator lets up on the motor treadle the needle positioner motor will seek the **DOWN POSITION** and run the machine until the needle reaches its lowest position then rises high enough to allow the point of the hook to enter the needle thread loop. This automatic positioning is used advantageously by the operator for pivoting and re-aligning the material without encountering a skip stitch or other problems.

**Fig. 80**



**Fig. 81** When the operator heels the treadle, the needle positioner will turn the machine at positioning speed until the needle is out of the material and the take-up is in the **UP POSITION**. It is during this rotation that the knife mechanism is activated. The movable knife moves into its proper position to pick up and cut both the needle thread and bobbin thread with a scissor type action. As the knife is activated, the tension on the needle thread is released, allowing the thread to be cut when relaxed. This will prevent the thread from snapping back up through the material and out of the eye of the needle, or leave a short tail.

**Fig. 81**

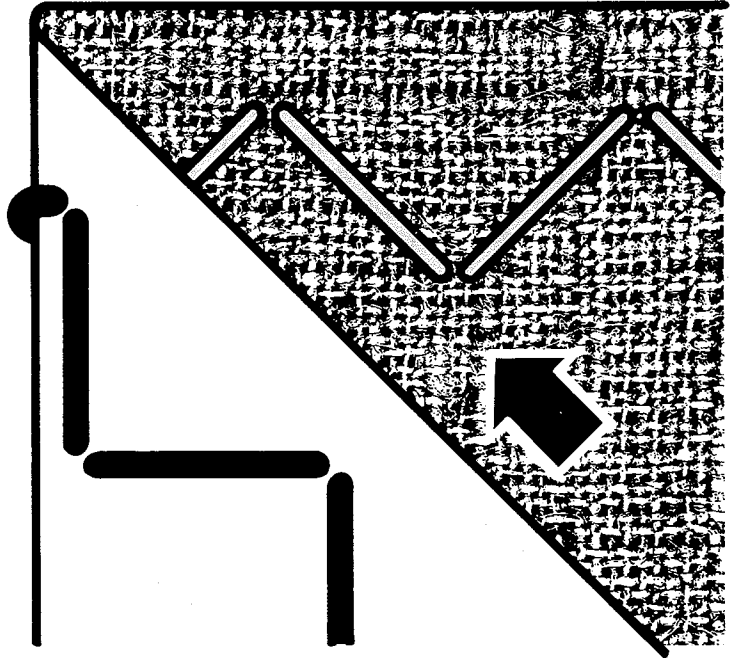


The needle positioning and thread trimming function occur in less than a second.

## OTHER STITCH TYPES

The principles discussed in this booklet for the 301 stitch formation can be applied to all other stitch formations within the 300 stitch class.

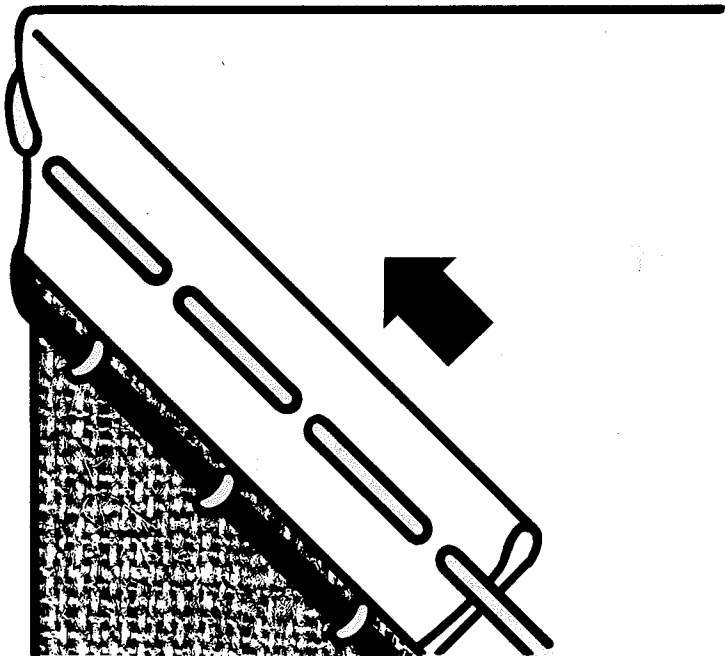
**Fig. 82** The 304 stitch formation is commonly referred to as the Zig-Zag Lockstitch. Its formation is similar to that of the 301 stitch. To produce the zig-zag appearance, the needle bar moves laterally when the material is being fed.



**Fig. 82**

**304 STITCH**

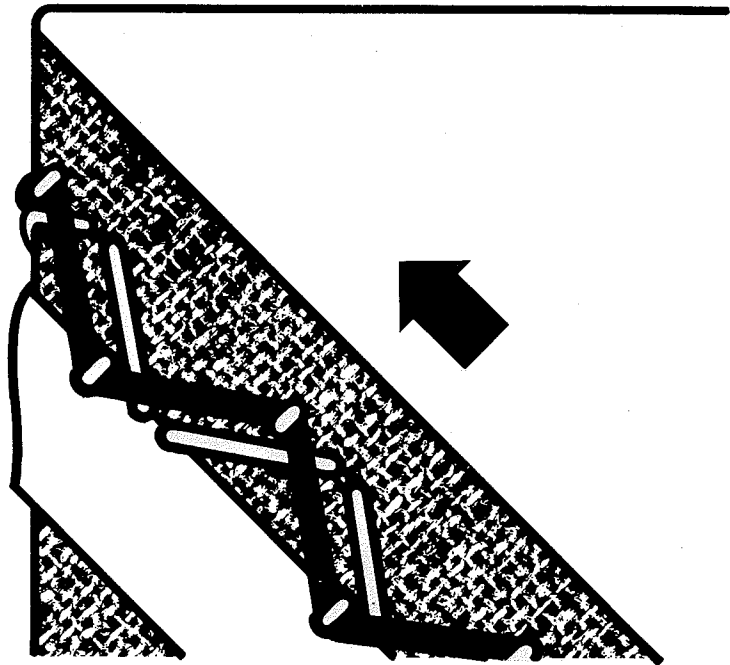
**Fig. 83** Stitch type 306 is a lock-stitch Blindstitch used primarily in men's clothing. Being a blindstitch machine, it uses a curved needle with the hook mounted above the material.



**Fig. 83**

**306 STITCH**

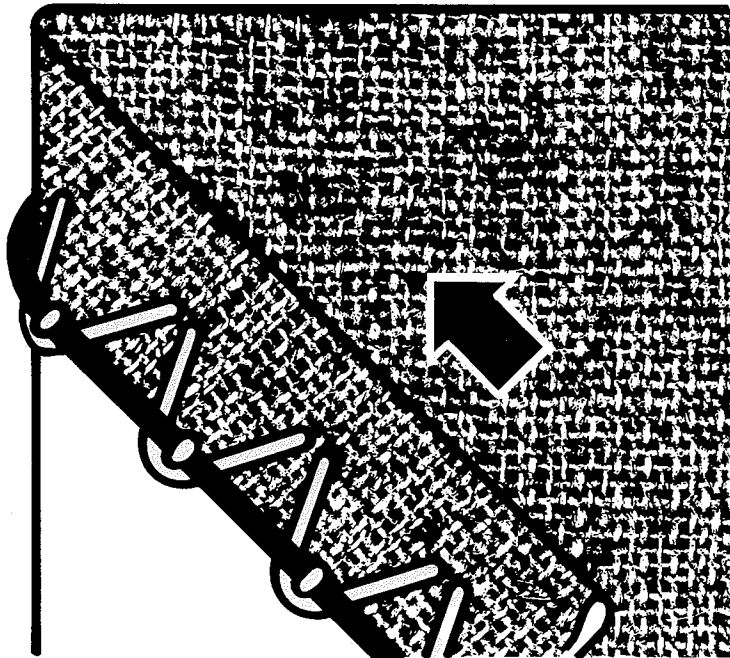
**Fig. 84** Stitch type 313 is also a blindstitch which is used in men's clothing for sewing the lining to the body of a coat and similar operations. In this stitch formation, the needle first penetrates the body of the material as it moves on its right hand stroke, then shogs and on the next down stroke penetrates the lining. When the operation is complete, no stitch is visible on either side of the seam.



**Fig. 84**

**313 STITCH**

**Fig. 85** Stitch type 314 is a blindstitch used in men's clothing for felling the under collar or felling the sleeve lining at the cuff on suit coats, etc. It is sometimes used for felling the waistband curtain of slacks. It utilizes a special scissors action spreading device to move the needle thread into its proper position during sewing.



**Fig. 85**

**314 STITCH**

